

**SIEMENS**

*Ingenuity for life*

Edition 04/2020

## SITOP Power Supply

Top integration. Top efficiency.  
Top reliability.

[siemens.com/sitop](https://www.siemens.com/sitop)

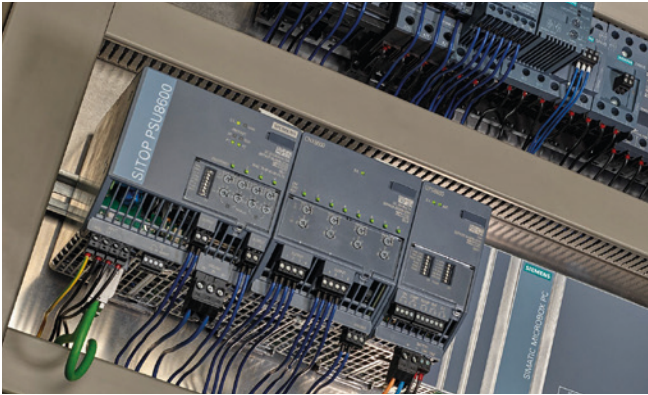

SITOP PSU8600 – a new 4 x 5 A basic unit enables the unique functions of the power supply system to be used in 1-phase systems – see page 6/7.



# SITOP power supplies bring production plants to life.



SITOP PSU6200 – the all-around power supply for a wide range of applications, now also for 3-phase networks – see pages 8/9.

An efficient power supply is a basic requirement for operating any plant, no matter the industry or need. Critical production processes can only be maintained if a constant power supply of the necessary quality is available for the automation system. For decades, SITOP – the heart of automation – has been bringing production plants to life. The complete, precisely coordinated range of products guarantees a reliable power supply, and is especially suited to the growing demands of our time.



### SITOP means top reliability

SITOP has proven its reliability in nearly all networks around the world. With a flexible, wide-range input, outstanding load characteristics, and all the relevant certifications, SITOP power supply units safeguard the availability of your plant. Add-on modules prevent problems on the line or DC side. And when upgraded to an uninterruptible power supply, the 24-V power supply units bridge power failures for a period of seconds, minutes, or hours. In the event of a fault-specific overload or short circuit in the output circuit, selective disconnection of

the feeder ensures continued operation, because the supply to other loads is maintained. For highly critical applications, redundant power supply solutions are also an option. If a replacement is ever needed, our global customer service ensures the fastest possible delivery: All SITOP products can be supplied from stock.



### SITOP means top efficiency

Reduced energy costs are a valuable competitive advantage. SITOP makes an important contribution, because the primary switched-mode power supply units operate highly efficiently. For example, SITOP PSU8200 and 6200 have an efficiency of up to 96 percent. Losses are low throughout the entire load range, even in no-load operation. This is because a power supply is rarely operated at full load. SITOP PSU8600, on the other hand, records power data from all outputs, which is then further processed in energy management systems. And via PROFinergy, power supply outputs can be switched off selectively: for example, during breaks.

Efficiency also characterizes the product lifecycle. With the TIA Selection Tool, we offer you special tools to make it easy to select a power supply and DC UPS. We provide you with all the design data for all common CAE systems as well as the corresponding product documentation.



### SITOP is top in integration

SITOP sets a benchmark in terms of integration: Complete integration of the SITOP PSU8600 power supply system and SITOP UPS1600 DC UPS in Totally Integrated Automation, the TIA Portal, and the new SITOP Manager saves time and money and facilitates fail-safe engineering. For the selectivity modules and the SITOP PSU6200 product line, S7 function blocks evaluate important diagnostic information. The SITOP UPS1600 can easily be integrated via USB or Ethernet to protect PC-based automation systems from power failures. And the SITOP library for SIMATIC PCS 7

enables a transparent 24-V supply in the process control system during ongoing operation.

Besides PROFINET, SITOP PSU8600 and SITOP UPS1600 also communicate via OPC UA. With the OPC UA server, it's also possible to directly integrate units such as controllers or PCs into automation applications with OPC UA clients from different vendors.

## Three SITOP categories for the different demands on an industrial power supply

### Advanced power supplies

The switched-mode power supply units in the Advanced performance class are the optimal choice for maximum reliability and functionality as required in the process and automotive industries, in special-purpose machine manufacturing, and in harsh environments. The SITOP PSU8200 product line meets these extreme requirements thanks, for example, to their overload behavior, efficiency, and compactness. SITOP PSU8600 also offers a power supply system with open communication for optimal integration into the digital environment.

### Standard power supplies

Our standard portfolio was designed for industrial applications like those in special-purpose machine manufacturing. Development of the new SITOP PSU6200 all-around power supply was based on our experience with the proven SITOP smart product line. This new SITOP standard power supply features even higher efficiency, comprehensive diagnostic options, and greater ruggedness.

### Basic power supplies

From flat power supplies for distribution boards to cost-effective basic power supplies and slim power supply units for control boxes – even in the low-performance range, SITOP leaves nothing to be desired. LOGO!Power offers you miniature power supply units in the LOGO!8 module design. And SITOP lite meets the most important requirements for reliable primary switched-mode regulators at an affordable price.

# Overview of SITOP product lines

What an optimal power supply looks like depends on numerous factors – size, performance range, and functions, to name but a few. The extensive range of SITOP products ensures that your power supply will always match your requirements.

## Advanced power supplies

## Standard power supplies



New! Now also 1-phase



New! Now also 3-phase and for 48 V



SITOP PSU8600

**The power supply system for digitalization and Industry 4.0**

The innovative SITOP PSU8600 power supply system is fully integrated into Totally Integrated Automation and the TIA Portal. It's integrated directly into networked automation applications via its Ethernet/PROFINET interface or OPC UA. SITOP PSU8600 not only offers brand-new functions and diagnostics options, it also supports the energy management of a plant or machine. The 4 x 5 A basic unit is now also available for single-phase.

Pages 20–23

SITOP PSU8200

**The technology power supply for demanding solutions**

SITOP PSU8200 is ideal for complex plants and machines. The wide-range input allows it to be connected to any supply system and also to withstand large voltage fluctuations. The power boost briefly delivers up to three times the rated current. And in the event of an overload, you can choose between constant current with automatic restart or latching shutdown. The high degree of efficiency reduces energy consumption, while the compact metal enclosure saves space.

Pages 24–25

SITOP PSU6200

**The all-around power supply for a wide range of applications**

SITOP PSU6200 is the extremely high-performance power supply for 24-, 12- and 48-V standard applications. The single-phase and brand-new 3-phase power supply units offer comprehensive functions and features for focused diagnostics, fast installation, and dependable operation. Whether it's LED status indicators, integration into preventive maintenance, push-in terminals, or rugged AC input – SITOP PSU6200 has it all.

Pages 26–27

SITOP smart

**The powerful standard power supply**

SITOP smart is the optimal power supply for many 24-V and 12-V applications, featuring compact design, powerful performance, and low price. Despite its compact size, it offers outstanding overload characteristics thanks to the extra power feature that provides 1.5 times the rated current for five seconds: Even large loads can be easily switched on. And with a rated capacity of 120 percent, these slim power supplies are among the most reliable of their kind.

Pages 28–29

## Basic power supplies

## SITOP DC/DC converters

## SIMATIC Design



SITOP lite

### The cost-effective basic power supply

SITOP lite is the power supply series for basic requirements in the industrial environment, offering all the important functions at a low cost – without compromising quality and reliability. The wide-range input with manual switchover supports connection to a wide range of single-phase supply systems.

Page 32



LOGO!Power

### The flat power supply for distribution boards

Small. Clever. LOGO!Power. The fourth generation of the globally proven miniature power supply units with a flat, stepped profile features high performance in a small space. The comprehensive functionality with flexible installation, current monitoring, and high energy efficiency permits universal use in applications with 5 V, 12 V, 15 V, and 24 V.

Pages 30–31



SITOP DC/DC converter

### Stable power supply despite fluctuating DC voltage

SITOP DC/DC converters provide a stable control voltage: in battery-powered vehicles, as a “refresher” on long lines, in power plants, and at the DC link converter of wind energy plants and machine tools.

Page 34–35

### The optimal supply for SIMATIC S7 and more

Page 33

## Special designs

### Equipped for special functions and conditions

Pages 36–37

# SITOP PSU8600 – the power supply system for digitalization and Industry 4.0

Complex plants set high requirements for the efficiency, flexibility and reliability of the components used. The innovative power supply system SITOP PSU8600 fulfills them all – thanks to its unique functionality, diagnostics capability, modular expandability and complete integration in TIA or via an OPC-UA server in many other systems.

## Advanced power supplies

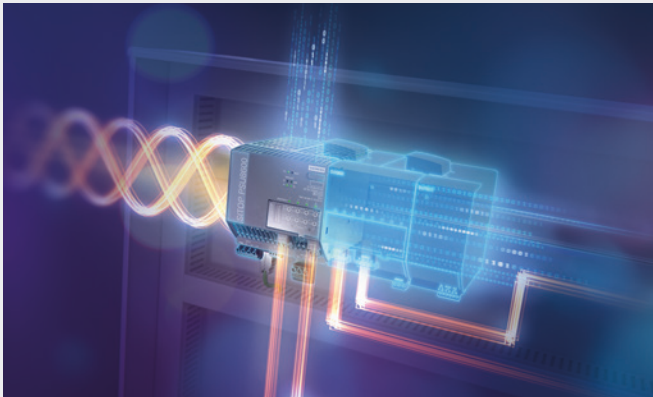

### SITOP PSU8600 – in dialog with your power supply

The SITOP power supply system includes the SITOP PSU8600 basic unit, the SITOP CNX8600 add-on modules, the SITOP BUF8600 buffer modules and the SITOP UPS8600 UPS module with the BAT8600 battery modules. It can be integrated seamlessly in TIA Portal, SIMATIC PCS 7 and WinCC. Due to the comprehensive data exchange over PROFINET or OPC-UA, the power supply is in constant dialog with the control unit and thus enables preventive maintenance and energy management in the control and load circuit.

**Did you know that...** even in buffer operation, the outputs exactly hold their set voltage and do not vary with battery voltage, as is common in other DC UPS systems?

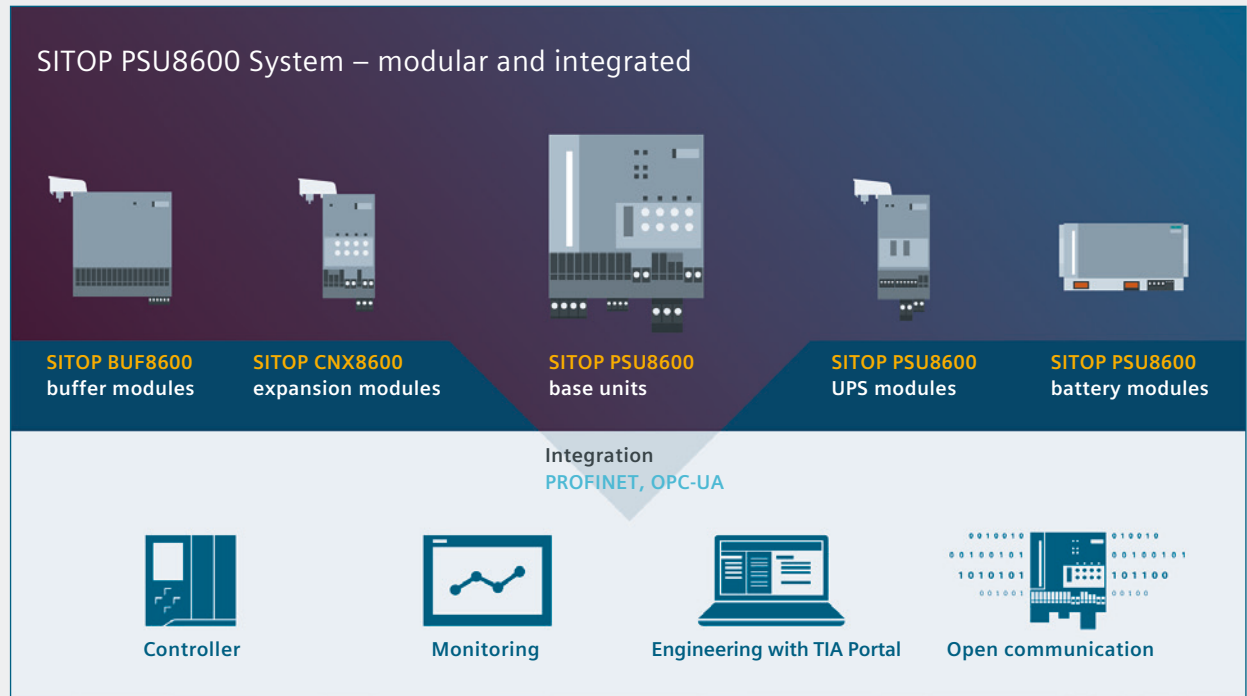

## The modular system toolbox



New: 1-phase  
basic unit  
20 A/4 x 5 A

### Base unit

Power supply 24 V/20 A or  
40 A with one or four  
selectively monitored  
outputs

### Expansion modules

Expansion to up to 36  
selectively monitored  
outputs

### Buffer modules

Bridging short power failures

### DC UPS and battery modules

Bridging long power failures

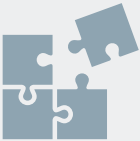

### Fast and easy integration in the automation

The SITOP PSU8600 power supply system can be integrated seamlessly in TIA portal, SIMATIC PCS 7 and WinCC. Two industrial PROFINET/ethernet ports enable the system to be integrated easily into the automation environment. Thanks to the open communication interface OPC UA, vendor-independent data exchange is possible.

The parameterization, operation and monitoring for this can take place via the user-friendly engineering and diagnostics software SITOP Manager. The integrated web server enables remote access. Due to the support of PROFIenergy, outputs can be switched off specifically and thus save energy and costs during break periods.



### High degree of flexibility thanks to modular system unit

The compact basic unit provides one or four individually adjustable outputs – and thus up to four power supplies in one device. Each output can be set flexibly to 4–28 V, even dynamically during operation and with selective monitoring for overcurrent. The “system clip link” can be used to extend the power supply system with various modules without additional wiring work and therefore expand it to up to 36 outputs and provide protection against supply system outages.



### High plant availability

The comprehensive diagnostics options of the SITOP PSU8600 power supply system provide the basis for preventive maintenance. Faults can therefore be detected, assigned and corrected in the shortest possible time. To ensure that a short-circuit or an overload in a single load does not lead the entire plant to a standstill. All outputs, whose voltage and current threshold can be set individually, are monitored selectively and in the event of a fault, are switched off individually. Because the current of each output can be recorded continuously and transmitted via PROFINET, overload states can be detected early. With the suitable buffer and battery modules, supply system failures can be bridged from seconds to hours, thus preventing a plant standstill.

# SITOP PSU6200 – the all-around power supply for a wide range of applications

A new benchmark in the area of standard power supplies: With its award-winning industrial design, space-saving width, optimized terminals, comprehensive diagnostics options, and high operational reliability, SITOP PSU6200 offers attractive prospects for a variety of different applications and areas of operations.

## Standard power supplies



### Focused diagnostics. Top integration.

With SITOP PSU6200 you benefit from a high degree of transparency during operation. Thanks to the integrated diagnostics monitor, in the more powerful units, an LED display on the housing enables immediate identification of how high the power supply's load is or whether the unit is coming to the end of its life. In this way it is possible to respond to critical states to prevent unforeseen plant failure.

Via the power supply unit's diagnostics interface, additional important operating parameters and statuses such as current, voltage, overload, operating hours, temperature, and device/type can be transferred to the controller and incorporated in condition monitoring. The signal is evaluated by means of a free S7 function block. In addition, a faceplate for visualizing the data on an HMI is available for download.

Did you know that ... only one digital input is required on the PLC for transferring comprehensive diagnoses?

#### Diagnostics monitor/Diagnostics interface

SITOP PSU6200 power supply units as of 24 V/10 A, 12 V/12 A and 48 V/5 A have a diagnostics monitor and a diagnostics interface. The diagnostics monitor indicates their operating status, current utilization, and end of service life via 5 LEDs.

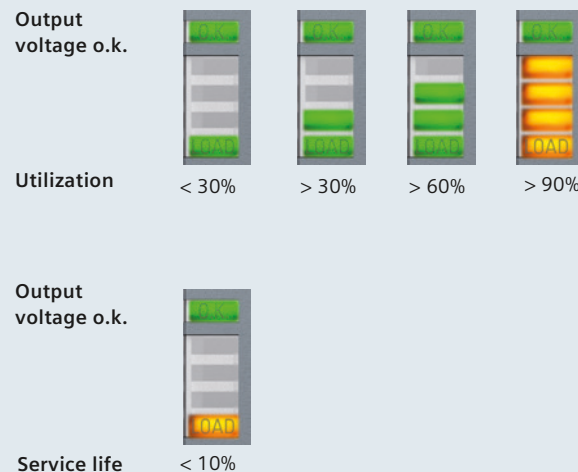

The diagnostics interface outputs a serial code to a digital input of a PLC that is evaluated by a function block. A WinCC faceplate makes visualization easy:

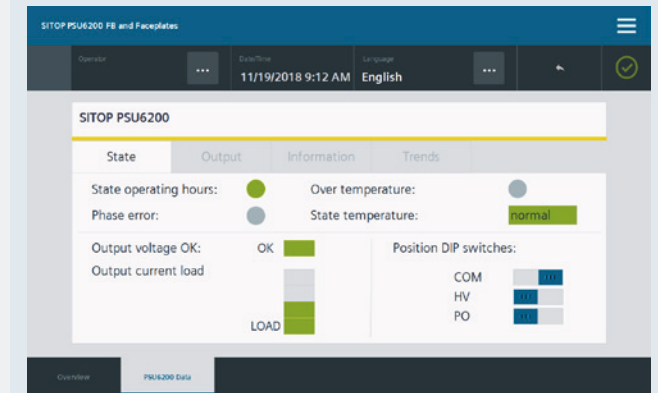



New: 3-phase power supply units 24 V/5 A, 10 A, and 20 A. 1-phase power supply unit 48 V/5 A

## The all-around power supply



### Fast installation. Top efficiency.

Space savings, front labeling, push-in terminals – with SITOP PSU6200, you make no compromises when installing and wiring. Inside the control cabinet, space is a valuable commodity. You can make even better use of this space, thanks to the extremely narrow width of the new power supply units. And thanks to optimized heat dissipation and an efficiency rate up to 96 percent, the units require no lateral clearance between components, which also saves space on the DIN rail.

The all-around power supplies also facilitate and speed up fail-safe wiring. Unique terminal labeling makes correct wire connection easier, and push-in terminals make wiring fast. An additional, uniquely identified minus terminal also makes it easier to ground PELV (protective extra-low voltage) circuits according to the Machinery Directive.



### Dependable operation. Top reliability.

Dependable overload behavior, robust input, and a metal enclosure for optimal heat dissipation – with SITOP PSU6200, you're on the safe side. Their extra power means that the high-performance power supply units provide a 50 percent higher rated current for up to five seconds in the event of an overload. If the overload is extremely high, they keep the current constant and change to hiccup mode for self-protection only when the output voltage drops to 15 volts. Once the overload has been corrected, they continue in normal operation.

In addition, you are ideally equipped against poor grid supply quality: Thanks to robust wide range input for AC and DC voltage, the all-rounder power supply units are well protected against under and overvoltages from the supply system. The brand new 400-V units even enable continuous operation in two phases in the event of a phase failure. The powerful power supply units also have an active power factor correction (PFC) function, which keeps the reactive current component and the making current low.

New redundancy and selectivity modules in the attractive SITOP PSU6200 design ensure even higher availability. See pages 12 and 13.



# SITOP ensures reliable 24-V supply – even when the power fails

Power outages can bring a plant to a standstill, with high costs in terms of both time and money. The SITOP DC UPS systems with different types of energy storage devices and communication interfaces offer solutions for all buffering time and plant integration requirements.

## Uninterruptible power supply



**DC UPS module**  
For expansion to an uninterruptible 24-V power supply



### SITOP DC UPS with capacitors

These high-capacitance double-layer capacitors (Ultracaps) store sufficient energy to shut down PC-based systems safely.

### Totally maintenance-free

The capacitors have an extremely long life even at high ambient temperatures. No maintenance or replacement of the energy buffer is required, which means that the DC UPS pays for itself within a short time. And because the capacitors do not emit any gas, no ventilation of the control cabinet is required. Short recharging times quickly restore buffering capability following a power failure.

### For use both inside and outside the control cabinet

The buffering time of the UPS500S for DIN rail mounting can be extended by adding UPS501S expansion modules.

- Variant expandable up to 20 kW for longer buffering times
- Capacitors eliminate replacement of batteries
- Long life even at high temperatures
- No ventilation of the installation site required
- Communication via contacts or USB
- Easy engineering via SITOP Manager (as of V1.1, see page 16 for more details)

**DC UPS module**  
For expansion to an uninterruptible 24-V power supply



### SITOP DC UPS with battery modules

Compact DC UPS modules ensure continued operation, even over a period of hours, depending on battery capacity and power requirements.

### High system availability thanks to battery management

Sophisticated battery management ensures optimal battery charging. The charging process is temperature-controlled thanks to the innovative SITOP UPS1600, which also increases the service life of the UPS1100 battery module.

- DC PSU module SITOP UPS1600 with 24 V and up to 40 A as well as battery module UPS1100 up to 12 Ah (total 72 Ah)
- SITOP UPS1100 5-Ah lithium battery module (LiFePo) with a constant power output and voltage throughout the discharging range as well as a long service life even with high ambient temperatures
- Monitoring of operational readiness, battery feeder, and charging status
- Extended battery life thanks to battery management

Did you know that ... you can connect the uninterruptible power supply SITOP UPS1600 to various different systems via OPC UA?

SITOP module for 24-V buffering	Buffer module	UPS500	UPS1600	
<b>Energy storage device</b>				
24-V buffering	max. 10 s	Minutes	Hours	
Storage medium	Electrolytic capacitors	Double-layer capacitors	Lead batteries	Lithium batteries
Service life (also temperature-dependent)	++	++	•	+
Application area (temperature, degree of protection, ventilation)	+	++	•	+
<b>UPS module/electronics</b>				
max. rated output current	40 A	15 A	40 A	
Overload capacity	++	+	++	
Interfaces		I/O, serial, USB	I/O, USB, Ethernet/PROFINET	
Operating and diagnostic information via				
– Signaling contacts		•	•	
– OPC UA server, Web server, S7 FBs, WinCC faceplate			•	
Shutting down multiple PCs/PLCs			•	
Start from battery without mains voltage (island operation)			•	
Engineering via SITOP Manager		•	•	
Engineering via TIA Portal, STEP 7, WinCC, or OPC UA			•	
SITOP library for SIMATIC PCS 7			•	

### Extremely communicative

Optional communication via USB or Industrial Ethernet/PROFINET. With open communication via Ethernet, configuration and diagnostics are conveniently performed by the SITOP Manager. This PC software with a user interface based on a Web browser permits simple parameterization: for example, for safely shutting down multiple PCs.

The UPS1600 can even be fully integrated into TIA via PROFINET. Remote monitoring is possible with support from the integrated web server.

- Communication via contacts, USB, or two Ethernet/PROFINET ports
- Easy engineering and extensive diagnostics in the TIA Portal
- OPC UA server for the flexible integration of a wide variety of automation, operating, and monitoring systems
- User-friendly SITOP Manager engineering and diagnostics tool for simple integration into open systems (more details on page 16)

SITOP DC UPS configuration with capacitors

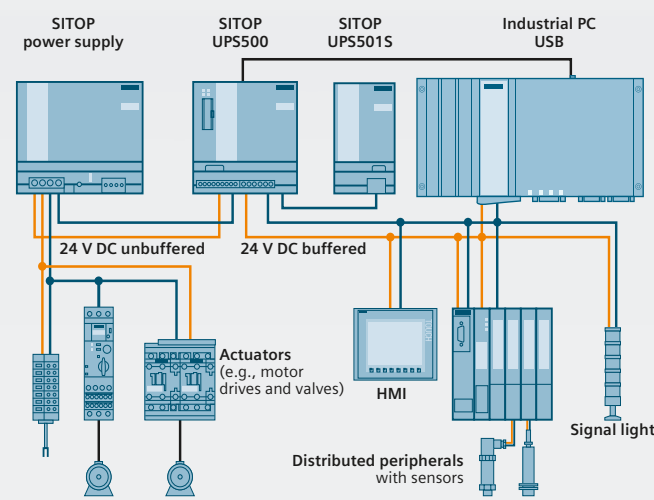

24-V buffering for saving process data and for correct PC shutdown

SITOP DC UPS configuration with battery modules

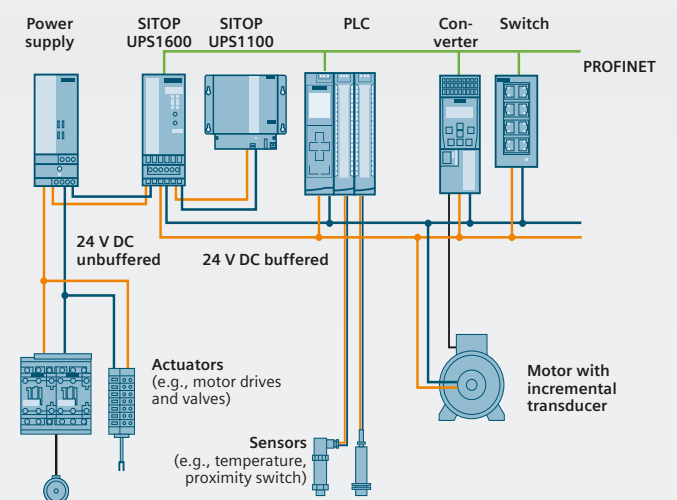

24-V buffering for maintaining communications, signaling, sensor-measured values, and position values

# SITOP add-on modules – all-round protection à la carte

Processes and plants that are critical for a company's business generally require additional protection measures. SITOP add-on modules individually protect your production against many sources of risk.

## Add-on-Module



### Add-on modules

For increasing system availability to all-round protection



#### Safeguarding against failure through redundancy

Two power supply units can be connected via the SITOP redundancy module for additional failure safety. If one unit fails, the other automatically takes over the power supply function. Even in the event of a short circuit inside a power supply unit, the power supply remains reliable. Thanks to its high dielectric strength, the new RED1200 redundancy module also decouples power supplies without output voltages up to 48 V.



#### Selective disconnection of faulty 24-V feeders

The SITOP selectivity modules are specifically tailored to switched-mode power supplies. The modules permit brief current peaks and switch off the electricity for longer overloads, even on long, thin cables and with creeping short circuits in which the current is limited by the high ohmic resistance. In this case the circuit-breakers do not trip, or they trip too late, even if the power supply could deliver the current. The selectivity modules reliably disconnect the faulty load circuits, and the supply to the other loads continues with absolutely no interruption so that total failure of the plant can be avoided. The affected feeder is indicated by an LED. The option with single-channel signaling also allows remote output-specific fault location. The new SEL1200 and SEL1400 four or eight-channel modules also have an interface with comprehensive diagnostics options for each output.

Selection matrix of the SITOP add-on modules for protection from...

	Redundancy module	Selectivity/diagnostic module	Buffer module	DC UPS with capacitors	DC UPS with batteries
Failure of a power supply unit	•				
Overload in the 24-V circuit		•			
Power failure up to the seconds range			•	•	•
Power failure up to the minutes range				•	•
Power failure up to the hours range					•



#### Buffer module bridges brief power failures

Power failures usually last only for a fraction of a second – but they can cause time- and cost-intensive damage. Used in combination with the 24-V DC power supply units from the SITOP smart, PSU6200, and PSU8200 product lines, the buffer module bridges short-duration voltage dips with its electrolytic capacitors and reliably preserves interruption-free operation.

Did you know that ... our customers use SITOP power supply units in manufacturing, process, and building automation in over 190 countries worldwide?

### Configuration with redundancy module

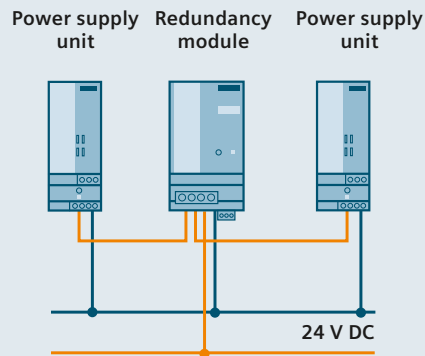

#### Your benefits with the redundancy module:

- Highly secure DC supply thanks to a redundant design
- Reliable supply even when one power supply fails
- Compact redundancy modules for power supply units up to 48 V and 40 A
- 24-V/NEC Class 2 redundancy module limited to 100 VA
- Decoupling of parallel-connected power supply units to enhance performance or of series-connected power supply units to increase voltage

### Configuration with selectivity module

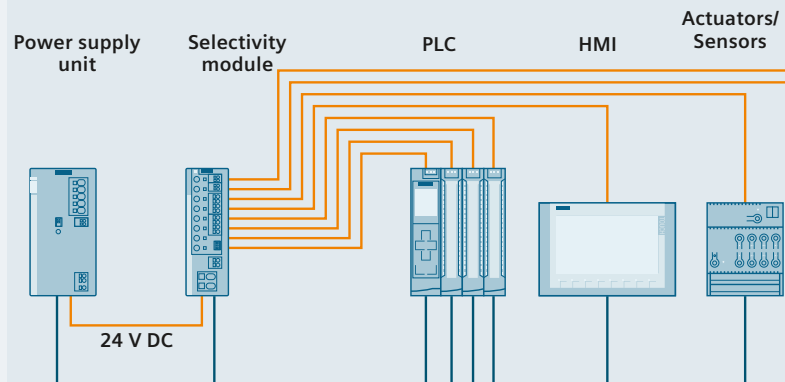

#### Your benefits with the selectivity module:

- Protection against overloads and short circuits in the 24-V circuit
- Reliable tripping, regardless of the line resistance
- SEL1200: switch-off characteristic for standard protection and high starting currents
- SEL1400/PSE200U: power limiting to meet high protection requirements by stabilizing the 24 V
- Sequential connection reduces total inrush current
- Common signaling contact or evaluation of individual channels
- SEL1200/1400: 4 or 8 outputs, each with diagnostics of voltage, current, set threshold, reason for disconnection (if applicable)
- PSE200U: 4 outputs with voltage measuring point for current ( $1 \text{ V} \pm 1 \text{ A}$ )

### Configuration with buffer module

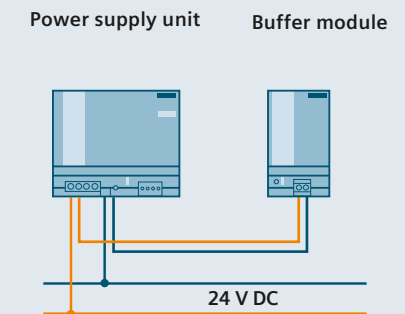

#### Your benefits with the buffer module:

- Inexpensive protection against power failure up to several seconds
- Support of power supply unit for temporarily increased power requirements
- High load current up to 40 A
- Connection to the power supply unit only via two lines

# Comprehensive support from planning to operation



CAD and CAE data in the image database for simple configuration

All product information is available per download via the CAx download manager.

No matter how many requirements a power supply must meet, SITOP always optimally supports your planning process – from product selection and mechanical and electrical design to project-specific plant documentation and engineering. With the TIA Selection Tool, you can select your power supply, add-on modules, and DC UPS faster and order it directly. In addition, you will automatically receive the required CAD data and circuit diagram macros. And using the TIA portal, you can even simply and reliably parameterize and diagnose the modular SITOP UPS8600 power supply system and the SITOP UPS1600 DC uninterruptible power supply.

## Efficiency starts with selection

With just a few mouse clicks, the TIA Selection Tool guides you to the optimal power supply for your requirements. Simply enter the relevant parameters. If there are multiple solutions, an overview offers a comparison table containing several devices. Once you've opted for a power supply, you can easily select the appropriate redundancy, selectivity, and DC UPS modules. You can then export the resulting product configuration to various CAD, CAE, and engineering systems (like the TIA Portal) and continue to use it. With a single mouse click, you can transfer the selected products to the Industry Mall shopping cart and conveniently order them from there. The 24-V consumer view in the TIA Selection Tool helps you easily select the power supply for your project by automatically calculating the power requirements of the automation products to be supplied.

## Everything you need for planning

Additional information – including 3D data, circuit diagram macros according to IEC or ANSI, certificates, and operating instructions – are available at the click of a mouse. With the aid of the CAx Manager, you can download engineering data in the DXF, STEP, EPLAN, and eCl@ss advanced formats and apply it directly to your project engineering. Not only does this save you a significant amount of valuable engineering time, but you also benefit from the configurable manuals when creating custom project documentation using My Documentation Manager.

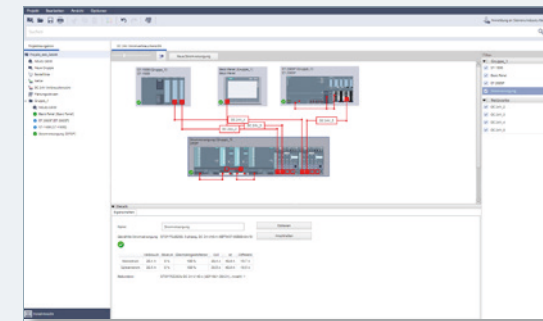

TIA Selection Tool: In the 24-V DC power consumer view, the necessary SITOP power supply can be easily selected for the chosen automation products.

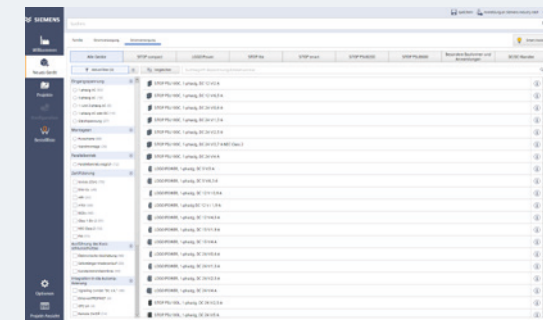

TIA Selection Tool: Power supply selection based on technical specifications

**Did you know that ...** SITOP PSU8600 and SITOP UPS1600 (version with IE/PN interface) have integrated Web servers that they can use for commissioning and remote diagnostics?

### Convenient engineering in the TIA Portal

You can easily perform the engineering tasks for the SITOP PSU8600 power supply system and the SITOP UPS1600 uninterruptible power supply via the TIA Portal. Device selection and network connection are a simple matter of drag-and-drop or copy-and-paste. In addition, function blocks for SIMATIC S7-300, 400, 1200, and 1500 are available for integrating the power supply system and DC UPS into STEP 7 user programs. There are also tailor-made faceplates to visualize the operational and diagnostic data using SIMATIC operating and monitoring systems. All of this helps reduce engineering effort and saves costs.

### Your advantages through system integration of SITOP UPS1600 and SITOP PSU8600

- Time and cost savings during configuration and operation
- Convenient engineering in the TIA portal
- Quick product selection and network integration in PROFINET
- Comprehensive parameterization of devices
- Comprehensive diagnostic options
- Simple integration into STEP 7 user programs with function blocks for S7-300/400/1200/1500
- Fast integration into operation and monitoring with faceplates for SIMATIC panels and SIMATIC WinCC

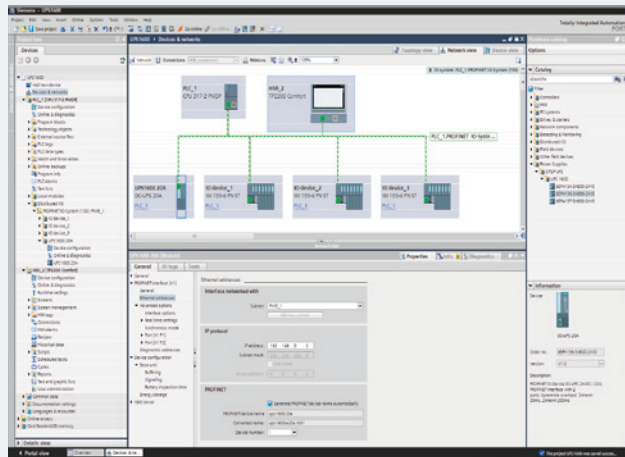

Integrating the SITOP UPS1600 DC UPS into PROFINET is easy and fail-safe via the TIA Portal.

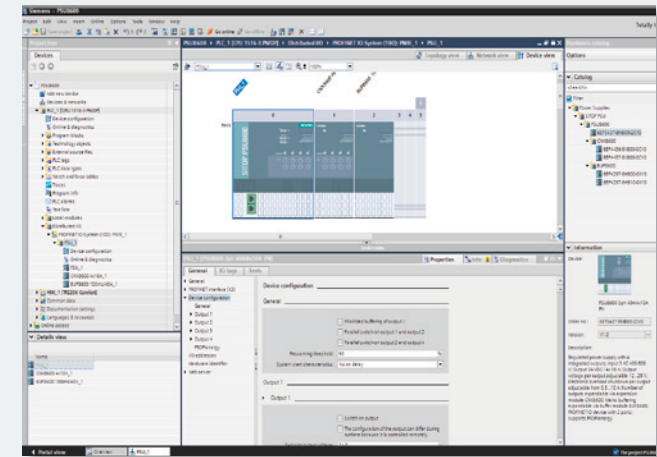

Configuring and setting parameters for the PSU8600 power supply system in the TIA Portal is both intuitive and convenient.



[siemens.com/  
tia-selection-tool](https://www.siemens.com/tia-selection-tool)

# SITOP Manager – the software for easy integration of SITOP PSU8600, UPS500, and UPS1600 in open systems



siemens.com/  
download-smgr

**Did you know that ...** with the new SITOP Manager V1.1, you can configure and diagnose uninterruptible SITOP power supplies with a USB interface, which also includes SITOP UPS500 and predecessors of UPS1600?

Optimal interoperability with different control systems: SITOP Manager – the Windows software for the SITOP PSU8600 power supply system and SITOP uninterruptible power supplies – is available free of charge.

## High performance for configuration

With the SITOP Manager software, all the power supplies in a network can be parameterized and diagnosed by a PC with the Windows 7 or 10 operating system. This is ideal, especially if plant configuration and programming isn't performed via the TIA Portal or SIMATIC Step 7. Thanks to a user interface based on a Web browser, the application can also run on mobile terminals and automatically adapts the display size.

With the user-friendly SITOP Manager software, it's easy to parameterize the SITOP PSU8600 power supply system and the SITOP uninterruptible power supplies – for example, to define output voltages and current thresholds or to safely shut down PCs in the event of a power failure.

## Uncompromising when it comes to security



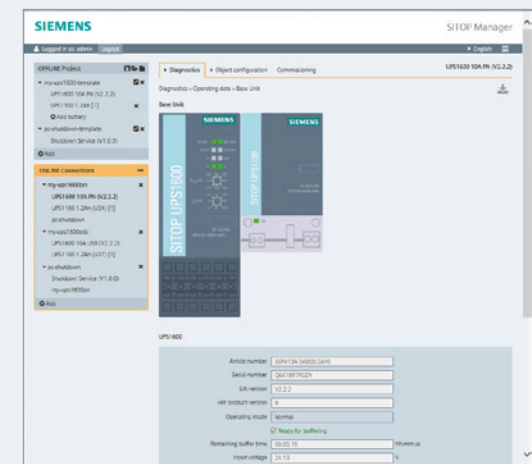















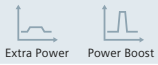



Communication between SITOP Manager and the connected power supplies is via the open, multi-vendor, Ethernet-based OPC UA communication standard. This standard meets extremely high security requirements for secure data transmission.



The status of the communication-capable SITOP devices can be conveniently obtained via online diagnostics in the SITOP Manager. Here is the operating data for the SITOP UPS1600/UPS1100.



# SITOP – the right power supply for every application

			Advanced power supplies	Standard power supplies	Basic power supplies			
Selection matrix of the SITOP DIN rail power supply units according to performance data and range of functions			SITOP PSU8600 – power supply system with PROFINET and OPC UA	SITOP PSU8200 – The technology power supply for demanding solutions	SITOP PSU6200 – the all-around power supply for a wide range of applications	SITOP smart – The powerful standard power supply	SITOP lite – The cost-effective basic power supply	LOGO!Power – The flat power supply for distribution boards
								
	Input	AC/DC	1,3 ~	1,2,3 ~ =	1,3 ~ =	1,3 ~	1 ~	1 ~ =
	Rated power up to approx.	P	960 W	960 W	480 W	960 W	480 W	100 W
	Rated output voltages	U 	5–24 V DC	24/36/48 V DC	12/24/48 V DC	12/24 V DC	24 V DC	5/12/15/24 V DC
	Rated output currents (24 V)	I	20–40 A	5–40 A	1.3–20 A	2.5–40 A	2.5–20 A	0.6–4.0 A
	Overload behavior	P <sub>max</sub> 						
	Energy efficiency		+++ 	+++	+++	++	+	++
	Automation integration			DC o.k. Remote on/off	DC o.k. Diagnostics interface	DC o.k.		
	Explosion protection: ATEX, IECEx, or FM		•	•		•		•
	Marine approval: DNV GL or ABS		•	•	in preparation	•		•
	Ambient temperature range		–25 ... +60 °C	–25 ... +70 °C	–25...+70 °C	–25 ... +70 °C	0 ... +60 °C	–25 ... +70 °C
	Redundancy module		•	•	•	•	•	•
	Selectivity module	 I >	integrated	•	•	•	•	•
	Buffer module	 s	integrated	•	•	•	•	•
	DC UPS with Ultracaps	 min	integrated	•	•	•	•	•
	DC UPS with batteries	 h	integrated	•	•	•	•	•

Our answers to your requirements with regard to a high-performance power supply:

The selection of the power supply unit is based on the input and output data. On the following two pages (pages 18 and 19), you will find a selection table with the available SITOP power supply units and the product lines to which they belong. The technical data is located on the subsequent pages under the corresponding product line.

But which product line is the right one for my application?

As a decision-making aid, you can refer to the selection matrix containing the most important data, properties, functions, certificates, and expansion options for increasing 24-V availability.



# Selection table SITOP power supplies

Input voltage	Output current	Advanced power supplies		Standard power supplies		Basic power supplies			SIMATIC design	SITOP DC/DC converter	
		SITOP PSU8600	SITOP PSU8200	SITOP PSU6200	SITOP smart	SITOP lite	LOGO!Power	SITOP compact			
<b>DC 24-V output voltage</b>											
<b>1-phase 120 V, 230 V AC</b>	0.6 A							6EP3330-6SB00-0AY0	6EP1331-5BA00		
	1.3 A			6EP3331-7SB00-0AX0				6EP3331-6SB00-0AY0	6EP1331-5BA10		
	2 A									6ES7307-1BA01-0AA0	
	2.5 A			6EP3332-7SB00-0AX0	6EP1332-2BA20	6EP1332-1LB00		6EP3332-6SB00-0AY0	6EP1332-5BA00	6EP1332-1SH71	
	3 A									6EP1332-4BA00	
	3.5 A									6EP1332-1SH31	
	3.7 A			6EP3333-7LB00-0AX0					6EP1332-5BA20		
	4 A							6EP3333-6SB00-0AY0	6EP1332-5BA10		
	5 A		6EP1333-3BA10 6EP3333-8SB00-0AY0	6EP3333-7SB00-0AX0	6EP1333-2BA20	6EP1333-1LB00				6ES7307-1EA01-0AA0 6ES7307-1EA80-0AA0 6EP7133-6AB00-0BNO	
	6.2 A										
	8 A									6EP1333-4BA00	
	10 A			6EP1334-3BA10 6EP3334-8SB00-0AY0	6EP3334-7SB00-3AX0	6EP1334-2BA20 6EP1334-2AA01-0AB0	6EP1334-1LB00			6ES7307-1KA02-0AA0 6EP7133-6AE00-0BNO	
	12.5 A										
	20 A			6EP1336-3BA10	6EP3336-7SB00-3AX0	6EP1336-2BA10	6EP1336-1LB00				
	20 A/4 x 5 A	6EP3336-8MB00-2CY0									
	40 A			6EP3337-8SB00-0AY0							
	<b>3-phase 400–500 V AC</b>	5 A		6EP1333-3BA10 <sup>1)</sup>	6EP3433-7SB00-0AX0	6EP1433-2BA20					
		8 A								6ES7148-4PC00-0HA0	
		10 A		6EP1334-3BA10 <sup>1)</sup>	6EP3434-7SB00-3AX0	6EP1434-2BA20					
		17 A									
20 A				6EP3436-8SB00-0AY0	6EP3436-7SB00-3AX0	6EP1436-2BA10					
		6EP3436-8SB00-2AY0									
20 A/ 4 x 5 A		6EP3436-8MB00-2CY0									
30 A											
40 A				6EP3437-8SB00-0AY0		6EP1437-2BA20					
40 A/ 4 x 10 A		6EP3437-8MB00-2CY0									
<b>12 V DC</b>	4 A								6EP3133-0TA10-0AY0		
<b>24–110 V DC</b>	2 A								6ES7305-1BA80-0AA0		
<b>24 V DC</b>	5 A								6EP3133-0TA00-0AY0		
	10 A								6EP3134-0TA00-0AY0		
<b>48 V DC</b>	3.5 A								6EP3233-0TA10-0AY0		
	5 A								6EP3233-0TA00-0AY0		
	10 A								6EP3234-0TA00-0AY0		
<b>110–300 V DC 120–240 V DC</b>	0.6 A							6EP3330-6SB00-0AY0	6EP1331-5BA00		
	1.3 A			6EP3331-7SB00-0AX0				6EP3331-6SB00-0AY0	6EP1331-5BA10		
	2.5 A			6EP3332-7SB00-0AX0				6EP3332-6SB00-0AY0	6EP1332-5BA00		
	3.7 A			6EP3333-7LB00-0AX0					6EP1332-5BA20		
	4 A							6EP3333-6SB00-0AY0	6EP1332-5BA10		
	5 A			6EP3333-7SB00-0AX0							
	10 A			6EP3334-7SB00-3AX0							
20 A			6EP3336-7SB00-3AX0								
<b>110–220 V DC</b>	20 A/4 x 5 A	6EP3336-8MB00-2CY0									
<b>88–350 V DC</b>	20 A		6EP1336-3BA10			6EP1336-1LB00					
<b>600 V DC</b>	20 A								6EP1536-3AA00		

Special designs	Input voltage	Output current	Advanced power supplies		Standard power supplies		Basic power supplies		SITOP DC/DC converter	Special designs and applications	
			SITOP PSU8600	SITOP PSU8200	SITOP PSU6200	SITOP smart	LOGO!Power	SITOP compact			
	<b>Output voltage</b>										
	<b>5, 12, 15, 48, etc., V DC</b>										
6EP1331-1LD00	<b>1-phase</b> <b>120 V, 230 V AC</b>	4–28 V/ 4 x 5 A	6EP3336-8SB00-2CY0								
6EP1332-1LD00		5 V/3 A							6EP3310-6SB00-0AYO		
		5 V/6.3 A							6EP3311-6SB00-0AYO		
		12 V/0.9 A							6EP3320-6SB00-0AYO		
6EP1332-1LD10		12 V/1.9 A							6EP3321-6SB00-0AYO		
6EP1333-1AL12		12 V/2.0 A	6EP3321-7SB00-0AXO				6EP1321-5BA00				
6EP1333-7CA00		12 V/3.0 A							6EP1321-1LD00		
		12 V/4.5 A							6EP3322-6SB00-0AYO		
6EP1333-1LD00		12 V/6.5 A							6EP1322-5BA10		
6EP1334-7CA00		12 V/7 A	6EP3323-7SB00-0AXO		6EP1322-2BA00						
6EP1334-1AL12		12 V/8.3 A							6EP1322-1LD00		
6EP3343-0SA00-0AYO		12 V/12 A	6EP3324-7SB00-3AXO								
6EP1334-1LD00		12 V/14 A					6EP1323-2BA00				
		15 V/1.9 A							6EP3321-6SB10-0AYO		
		15 V/4 A							6EP3322-6SB10-0AYO		
		48 V/5 A	6EP3344-7SB00-3AXO				6EP3344-0SB00-0AYO				
6EP1433-0AA00		3–52 V/ 2–10 A							6EP3343-0SA00-0AYO		
6ES7148-4PC00-0HA0		2 x 15 V/ 3.5 A							6EP1353-0AA00		
6EP3436-8UB00-0AYO		<b>24 V DC</b>	12 V/2.5 A							6EP1621-2BA00	
			12 V/8 A							6EP3123-0TA00-0AYO	
		12 V/15 A							6EP3124-0TA00-0AYO		
	<b>3-phase</b> <b>400–500 V AC</b>	4–28 V/20 A	6EP3436-8SB00-2CY0								
6EP3437-8UB00-0AYO		4–28 V/ 4 x 5 A	6EP3436-8MB00-2CY0								
6EP3437-8UB00-0AYO		4–28 V/ 40 A	6EP3437-8SB00-2CY0								
		4–28 V/ 4 x 10 A	6EP3437-8MB00-2CY0								
		12 V/20 A							6EP3424-8UB00-0AYO		
6EP1732-0AA0 (as of 48 V DC)		36 V/13 A	6EP3446-8SB10-0AYO								
		48 V/10 A	6EP3446-8SB00-0AYO								
		48 V/20 A	6EP3447-8SB00-0AYO								

# SITOP PSU8600 advanced power supplies

## The power supply system for digitalization and industry 4.0

	new!				
					
Technical data	SITOP PSU8600 1- and 2-phase <sup>1)</sup> basic unit, 4 outputs	SITOP PSU8600 3-phase basic unit, 1 output		SITOP PSU8600 3-phase basic unit, 4 outputs	SITOP PSU8600 3-phase basic unit, 4 outputs
<b>Output voltage/current, type</b>	<b>24 V/20 A/4x5 A, PSU8600</b>	<b>24 V/20 A, PSU8600</b>	<b>24 V/40 A, PSU8600</b>	<b>24 V/20 A/4x5 A, PSU8600</b>	<b>24 V/40 A/4x10 A, PSU8600</b>
Article No.	6EP3336-8MB00-2CY0	6EP3436-8SB00-2AY0	6EP3437-8SB00-2AY0	6EP3436-8MB00-2CY0	6EP3437-8MB00-2CY0
Rated input voltage	100-240 V AC, 110-220 V DC	400-500 V 3 AC	400-500 V 3 AC	400-500 V 3 AC	400-500 V 3 AC
– Range	85...275 V AC, 93...275 V DC	320...575 V 3 AC	320...575 V 3 AC	320...575 V 3 AC	320...575 V 3 AC
Mains buffering	> 20 ms (at 100 V), extendable via buffer module or UPS module	> 15 ms (at 400 V), extendable via buffer modules and UPS module			
Rated line frequency	50/60 Hz	50/60 Hz	50/60 Hz	50/60 Hz	50/60 Hz
Rated input current	5.4-2.4 A, 4.8-2.4 A	1.4-1.1 A	2.75-2.2 A	1.4-1.1 A	2.75-2.2 A
– Inrush current	< 15 A	< 14 A	< 14 A	< 14 A	< 14 A
– Recommended protection	10-32 A character C or time-lag fuses	6-16 A charact. C 3-ph. coupled or 3RV2011-1DA10 (setting 3 A) or 3RV2711-1DD10			
Rated output voltage	24 V DC	24 V DC	24 V DC	24 V DC	24 V DC
– Tolerance	± 3%	± 3%	± 3%	± 3%	± 3%
– Setting range	4...28 V DC	4...28 V DC	4...28 V DC	4...28 V DC	4...28 V DC
– Rated output current	20 A, 4 outputs each with 5 A, number expandable via CNX modules	20 A, one output, number can be increased via CNX module	40 A, one output, number can be increased via CNX module	20 A, four outputs at 5 A each, number can be increased via CNX module	40 A, four outputs at 10 A each, number can be increased via CNX module
– Overload behavior (Extra Power)	30 A for 5 s/min	30 A for 5 s/min	60 A for 5 s/min	30 A for 5 s/min	60 A for 5 s/min
– Derating	-	From +50 °C (2.5%/K); no derating in connection with expansion module and total load of basic devices' output up to 240 W (20-A devices) or up to 480 W (40-A devices)			
Switching threshold adjustment range	0.5...5 A	2...20 A	4...40 A	0.5...5 A	0.5...10 A
Shutdown behavior per output	Load current 101...149 % of the setting: shutdown after 5 s; load current >150 % of the setting: Current limitation and shutdown after 200 ms				
Efficiency at rated values, approx.	92%	93%	94%	93%	94%
Signaling contact "DC o. k."	Yes	Yes	Yes	Yes	Yes
Interface	Industrial Ethernet/PROFINET with two ports				
Parallel switching	Yes, output 1 with 2 or 3 with 4	Yes	Yes	Yes, output 1 with 2 or 3 with 4 selectable via DIP switch	
Radio interference suppression (EN 55022)	Class B	Class B	Class B	Class B	Class B
Line harmonics limitation (EN 61000-3-2)	Yes	Yes	Yes	Yes	Yes
Degree of protection (EN 60529)	IP 20	IP20	IP20	IP20	IP20
Ambient temperature	-25...+60 °C	-25...+60 °C	-25...+60 °C	-25...+60 °C	-25...+60 °C
Dimensions (W x H x D) in mm	125 x 125 x 150	80 x 125 x 150	125 x 125 x 150	100 x 125 x 150	125 x 125 x 150
Weight approx.	2.65 kg	1.8 kg	2.65 kg	2.0 kg	2.65 kg
Certification	CE, cULus, CB, ATEX (further in preparation)	CE, cULus, CB, cCSAus, IECEx, ATEX, cCSAus Class I Div 2, SEMI F47, DNV GL, ABS			
System expandability	Up to 4 expansion modules (CNX8600) and up to 2 buffer components (BUF8600, UPS8600)				







Technical data	Expansion module		
Output current, typ	4 x 5 A, CNX8600	4 x 10 A, CNX8600	8 x 2.5 A, CNX8600
Article No.	6EP4436-8XB00-0CY0	6EP4437-8XB00-0CY0	6EP4436-8XB00-0DY0
Product/function description	Expansion module for PSU8600 basic devices for distribution of the direct current to other load circuits and monitoring for overload; selective switch-off of defective circuits, switching threshold individually configurable; a total of four modules can be used in a group of systems; data and power are transmitted via the System Clip Link connector		
Rated output voltage	24 V DC	24 V DC	24 V DC
– Tolerance	± 3 %	± 3 %	± 3 %
– Setting range	4...28 V DC	4...28 V DC	4...28 V DC
Rated output current	20 A/4 outputs of 5 A each	40 A/4 outputs of 10 A each	20 A/8 outputs of 2.5 A each
	Comment: The max. output capacity of the overall PSU8600 system cannot be increased via expansion modules		
– Switching threshold adjustment range	0.5...5 A	0.5...10 A	0.5...2.5 A
– Shutdown behavior per output	Load current 101...149 % of the setting: shutdown after 5 s; load current >150 % of the setting: Current limitation and shutdown after 200 ms		
Degree of protection (EN 60529)	IP 20	IP 20	IP 20
Ambient temperature	–25...+60 °C	–25...+60 °C	–25...+60 °C
Dimensions (W x H x D) in mm	60 x 125 x 150	60 x 125 x 150	100 x 125 x 150
Weight approx.	1.15 kg	1.15 kg	1.29 kg
Certification	CE, cULus, CB, cCSAus, IECEx, ATEX, cCSAus Class I Div 2, DNV GL; ABS, 6EP4436-8XB00-0DY0: NEC Class 2		

<sup>1)</sup> 2-phase connection to 240 V, e.g. in North America  
 Specifications at rated input voltage and ambient temperature at +25 °C (unless otherwise specified)

# SITOP PSU8600 advanced power supplies



## The power supply system for digitalization and industry 4.0

				
Technical data	Buffer module			
Buffer time, type	100 ms/40 A, BUF8600	300 ms/40 A, BUF8600	4 s/40 A, BUF8600	10 s/40 A, BUF8600
Article No.	6EP4297-8HB00-OXY0	6EP4297-8HB10-OXY0	6EP4293-8HB00-OXY0	6EP4295-8HB00-OXY0
Product/function description	Expansion module for PSU8600 basic devices to extend buffering time during power failures. A total of two buffer components (BUF8600, UPS8600) can be used in a group of systems. Data and power are transmitted via the System Clip Link connector.			
Internal energy storage	Electrolytic capacitors		Double-layer capacitors (Ultracaps)	
Buffer time with 24 V DC and load current				
5 A	800 ms	2.4 s	40 s	80 s
10 A	400 ms	1.2 s	20 s	40 s
20 A	200 ms	600 ms	10 s	20 s
40 A	100 ms	300 ms	4 s	10 s
Typical charging time	19 s	54 s	5 min	10 min
Max. power during buffer operation	60 A for 5 s/min	60 A for 5 s/min	40 A	60 A for 5 s/min
Status messages via 3-color LED	Normal operation, state of charge, buffer operation, error		Normal operation, state of charge, buffer operation, error	
Status messages via signal contact	–		State of charge > x %, buffer operation	
Status messages via PROFINET (basic unit)	Normal operation, state of charge, buffer operation, error		Normal operation, state of charge, buffer operation, error	
Additional functions	–		Remote on/off contact for deactivating buffering, e.g., when shutting down the plant to prevent unnecessary discharge	
Degree of protection (EN 60529)	IP 20	IP 20	IP 20	IP 20
Ambient temperature	–25...+60 °C	–25...+60 °C	–25...+60 °C	–25...+60 °C
Dimensions (W x H x D) in mm	60 x 125 x 150	125 x 125 x 150	60 x 125 x 150	125 x 125 x 150
Weight approx.	1.33 kg	2.26 kg	1.25 kg	1.95 kg
Certification	CE, cULus, CB, cCSAus, IECEx, ATEX, cCSAus Class I Div 2, SEMI F47, DNV GL, ABS		CE, cULus, CB, cCSAus, IECEx, ATEX, cCSAus Class I Div 2, SEMI F47, DNV GL, ABS	



Specifications at rated input voltage and ambient temperature at +25 °C (unless otherwise specified)



Technical data	
UPS module	
<b>Type</b>	<b>UPS8600</b>
Article No.	6EP4197-8AB00-OXYO
Product/function description	Expansion module for PSU8600 basic devices to bridge power failures with BAT8600 external battery modules. A total of two buffer components (BUF8600, UPS8600) can be used in a group of systems. Data and power are transmitted via the System Clip Link connector.
External energy storage	Battery module BAT8600
Buffer output	960 W
Charge power	120 W, 60 W (switchable)
Status messages via 3-color LED	Normal operation, battery status, buffer operation, error
Status messages via signal contact	State of charge > x%, buffer operation, battery circuit error
Status messages via IE/PROFINET (basic unit)	Normal operation, battery status, buffer operation, error
Additional functions	Maximum buffer time, remote ON/OFF, start from battery
Degree of protection (EN 60529)	IP 20
Ambient temperature	-25...+60 °C
Installation	DIN rail
Dimensions (W x H x D) in mm	60 x 125 x 150
Weight approx.	0.9 kg
Certification	CE, cULus, CB, cCSAus, IECEx, ATEX, cCSAus Class I Div 2, DNV GL, in preparation: ABS

Technical data		
Battery module		
Type	BAT8600 Pb	BAT8600 LiFePO4
Article No.	6EP4145-8GB00-OXYO	6EP4143-8JB00-OXYO
Product/function description	External energy storage device for UPS module UPS8600. Connection to the UPS module via plus and minus lines for power transmission as well as via the "Energy Storage Link" for data transmission. The Energy Storage Link enables diagnosis and temperature-controlled charging for maximum battery service life. Up to five identical battery modules can be connected to one UPS module.	
Battery/storage technology	Lead (Pb)	Lithium iron phosphate (LiFePO4)
Energy content	380 Wh	264 Wh
Rated voltage	48 V DC	48 V DC
Voltage range	42-58 V	42-58 V
Status messages via 3-color LED	State of charge, battery test/capacity test, battery replacement, overtemperature, error	
Overload and short-circuit protection	Blade fuse 40 A/58 V	Blade fuse 40 A/58 V
Parallel switching	yes, up to five (identical) units	yes, up to five (identical) units
Degree of protection (EN 60529)	IP 20	IP 20
Ambient temperature	-10...+50 °C	-10...+50 °C
Installation	Wall mounting	Wall mounting
Dimensions (W x H x D) in mm	322 x 187 x 110	322 x 187 x 110
Weight approx.	13 kg	6.5 kg
Certification	CE, UR, CB, cCSAus, IECEx, ATEX, cCSAus Class I Div 2, DNV GL, in preparation: ABS	CE, CB, cCSAus, DNV GL, in preparation: ABS

System output capacity		
Buffer times <sup>1)</sup>		
120 W	2 h 4 min	1 h 56 min
240 W	57 min	60 min
480 W	25 min	29 min
720 W	19 min	22 min
960 W	10 min	14 min
Charging capacity	Charging times	
120 W/60 W (switchable)	2 h 45 min (120 W)	2 h 40 min (120 W)
Ambient temperature	Service life <sup>2)</sup>	
+ 20 °C	4 years	15 years
+ 30 °C	2 years	10 years
+ 40 °C	1 year	9 years
+ 50 °C	0.5 years	2 years

<sup>1)</sup> Typical buffer times for a new fully-charged battery module at 25 °C

<sup>2)</sup> Typical end of service life according to EUROBAT: reduction to 80% of original capacity

Specifications at rated input voltage and ambient temperature +25 °C (unless otherwise specified)







# SITOP PSU8200 advanced power supplies

## Technology power supply for demanding applications



Technical data	SITOP PSU8200 1-phase				SITOP PSU200M 1-phase/2-phase <sup>2)</sup>
Output voltage/current, type	24 V/5 A, PSU8200	24 V/10 A, PSU8200	24 V/20 A, PSU8200	24 V/40 A, PSU8200	24 V/5 A, PSU200M
Article No.	6EP3333-8SB00-0AY0	6EP3334-8SB00-0AY0	6EP1336-3BA10	6EP3337-8SB00-0AY0	6EP1333-3BA10
Rated input voltage – Range	120–230 V AC 85...132/170...264 V AC, automatic range switching	120–230 V AC 85...275 V AC or 88...350 V DC	120–230 V AC 85...275 V AC or 88...350 V DC	120/230 V AC 85...132/170...264 V AC, automatic range switching	120–230/230–500 V AC 85...264/176...550 V AC
Mains buffering	> 35 ms (at 120/230 V)	> 35 ms (at 120/230 V)	> 20 ms (at 120/230 V)	> 25 ms (at 230 V)	> 25 ms (at 120/230 V)
Rated line frequency	50/60 Hz	50/60 Hz	50/60 Hz	50/60 Hz	50/60 Hz
Rated input current – Inrush current <sup>1)</sup> – Recommended miniature circuit breaker	2.1/1.2 A < 10 A 6 A charact. C or 3RV1021-1xA10	4.0/1.9 A < 10 A 10 A charact. C or 3RV1021-1xA10	4.6–2.5 A < 20 A 10 A charact. C or 3RV1021-1xA10	15.0/8.0 A < 50 A 20 A charact. C or 3RV2411-xxA10	2.2–1.2/1.2–0.61 A < 35 A 6 A charact. C or 3RV2011-1xA10
Rated output voltage – Tolerance – Setting range	24 V DC ± 3 % 24...28.8 V DC	24 V DC ± 3 % 24...28.8 V DC	24 V DC ± 3 % 24...28.8 V DC	24 V DC ± 3 % 24...28.8 V DC	24 V DC ± 3 % 24...28.8 V DC
Rated output current – Overload behavior (power boost for 25 ms) – Overload behavior (extra power for 5 s/min) – Derating	5 A 15 A 7.5 A -	10 A 30 A 15 A from +60 °C (2%/K)	20 A 60 A 30 A from +60 °C (3%/K)	40 A 120 A 60 A from +60 °C (2.5%/K)	5 A 15 A No from +60 °C (2%/K)
Efficiency at rated values, approx.	93 %	94 %	93 %	92 %	88 %
Signaling contact "DC o. k."	Yes	Yes	Yes	Yes	Yes
Remote On/Off	Yes	Yes	No	No	No
Parallel switching	Yes, output characteristic can be switched to parallel operation				
Electronic short-circuit protection	Yes, constant current or latching shutdown selectable; constant current: approx. 1.15 x rated output current				
Radio interference suppression (EN 55022)	Class B	Class B	Class B	Class B	Class B
Supply harmonics limitation	yes (EN 61000-3-2)	yes (EN 61000-3-2)	yes (EN 61000-3-2)	yes (EN 61000-3-2)	yes (EN 61000-3-2)
Degree of protection (EN 60529)	IP20	IP20	IP20	IP20	IP20
Ambient temperature	–25...+70 °C	–25...+70 °C	–25...+70 °C	–25...+70 °C	–25...+70 °C
Dimensions (W x H x D) in mm	45 x 125 x 125	55 x 125 x 125	90 x 125 x 125	145 x 145 x 150	70 x 125 x 121
Weight approx.	0.8 kg	1 kg	1.5 kg	3.1 kg	0.6 kg
Certification	CE, cULus, CB, ATEX, IECEx, cCSAus Class I Div 2, SEMI F47 <sup>3)</sup> , DNV GL, ABS	CE, cULus, CB, ATEX, IECEx, cCSAus Class I Div 2, SEMI F47 <sup>3)</sup> , DNV GL, ABS	CE, cULus, ATEX, IECEx, UL Class I Div 2, DNV GL, ABS	CE, cULus, CB, ATEX, IECEx, cCSAus Class I Div 2, SEMI F47 <sup>4)</sup> , DNV GL, ABS	CE, cULus, CB, ATEX, IECEx, UL Class I Div 2, SEMI F47 <sup>3)</sup> , DNV GL, ABS



					
SITOP PSU200M 1-phase/2-phase <sup>2)</sup>	SITOP PSU8200 3-phase		SITOP PSU8200 3-phase, 36 V	SITOP PSU8200 3-phase, 48 V	
<b>24 V/10 A, PSU200M</b>	<b>24 V/20 A, PSU8200</b>	<b>24 V/40 A, PSU8200</b>	<b>36 V/13 A, PSU8200</b>	<b>48 V/10 A, PSU8200</b>	<b>48 V/20 A, PSU8200</b>
6EP1334-3BA10	6EP3436-8SB00-0AY0	6EP3437-8SB00-0AY0	6EP3446-8SB10-0AY0	6EP3446-8SB00-0AY0	6EP3447-8SB00-0AY0 <sup>4)</sup>
120–230/230–500 V AC 85...264/176...550 V AC	400–500 V 3 AC 320...575 V 3 AC	400–500 V 3 AC 320...575 V 3 AC	400–500 V 3 AC 320...575 V 3 AC	400–500 V 3 AC 320...575 V 3 AC	400–500 V 3 AC 320...575 V 3 AC
> 25 ms (at 120/230 V)	> 15 ms (at 400 V)	> 10 ms (at 400 V)	> 15 ms (at 400 V)	> 15 ms (at 400 V)	> 10 ms (at 400 V)
50/60 Hz	50/60 Hz	50/60 Hz	50/60 Hz	50/60 Hz	50/60 Hz
4.4–2.4/2.4–1.1 A < 35 A 6 A charact. C or 3RV2011-1xA10	1.2–1.0 A < 18 A 6–16 A charact. C 3-ph. coupled or 3RV2011-1DA10 or 3RV2711-1DD10	2.1–1.7 A < 13 A 10–16 A charact. C 3-ph. coupled or 3RV2011-1DA10 or 3RV2711-1DD10	1.2–1.7 A < 18 A 6–16 A charact. C 3-ph. coupled or 3RV2011-1DA10 or 3RV2711-1DD10	1.2–1.0 A < 18 A 6–16 A charact. C 3-ph. coupled or 3RV2011-1DA10 or 3RV2711-1DD10	2–1.7 A < 13 A 10–16 A charact. C 3-ph. coupled or 3RV2011-1DA10 or 3RV2711-1DD10
24 V DC ± 3% 24...28.8 V DC	24 V DC ± 3% 24...28.8 V DC	24 V DC ± 3% 24...28 V DC	36 V DC ± 3% 32...40 V DC	48 V DC ± 3% 42...56 V DC	48 V DC ± 3% 46...56 V DC
10 A 30 A	20 A 60 A	40 A 120 A	13 A 39 A	10 A 23 A	20 A 60 A
No	30 A	60 A	19.5 A	15 A	30 A
from +60 °C (2%/K)	from +60 °C (3%/K)	from +60 °C (4%/K)	from +60 °C (3%/K)	from +60 °C (3%/K)	from +60 °C (4%/K)
91 %	94 %	94 %	94 %	93 %	94 %
Yes	Yes	Yes	Yes	Yes	Yes
No	Yes	Yes	Yes	Yes	Yes
Yes, output characteristic can be switched to parallel operation					
Yes, constant current or latching shutdown selectable; constant current: approx. 1.15 x rated output current					
Class B	Class B	Class B	Class B	Class B	Class B
yes (EN 61000-3-2)	yes (EN 61000-3-2)	yes (EN 61000-3-2)	yes (EN 61000-3-2)	yes (EN 61000-3-2)	yes (EN 61000-3-2)
IP20	IP20	IP20	IP20	IP20	IP20
–25...+70 °C	–25...+70 °C	–25...+70 °C	–10...+70 °C	–25...+70 °C	–25...+70 °C
70 x 125 x 121	70 x 125 x 125	135 x 145 x 150	70 x 125 x 125	70 x 125 x 125	135 x 145 x 150
1.4 kg	1.2 kg	3.3 kg	1.2 kg	1.2 kg	3.3 kg
CE, cULus, CB, ATEX, IECEx, UL Class I Div 2, SEMI F47 <sup>3)</sup> , DNV GL, ABS	CE, cULus, CB, ATEX, IECEx, UL Class I Div 2, SEMI F47, DNV GL, ABS	CE, cULus, CB, ATEX, IECEx, cCSAus Class I Div 2, SEMI F47, in preparation: DNV GL, ABS	CE, cULus, CB, cCSAus Class I Div 2	CE, cULus, CB, ATEX, IECEx, cCSAus Class I Div 2, DNV GL, ABS	CE, cULus, CB, ATEX, IECEx, cCSAus Class I Div 2, SEMI F47

# New: SITOP PSU6200 standard power supplies

## The all-around power supply for a wide range of applications

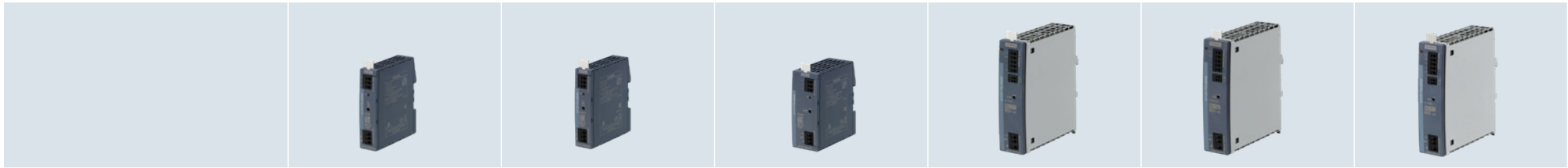

Technical data	SITOP PSU6200 1-phase					
<b>Output voltage/current, type</b>	<b>12 V/2 A, PSU6200</b>	<b>24 V/1.3 A, PSU6200</b>	<b>24 V/2,5 A, PSU6200</b>	<b>12 V/7 A, PSU6200</b>	<b>24 V/3,7 A, PSU6200</b>	<b>24 V/5 A, PSU6200</b>
Article No.	6EP3321-7SB00-0AX0	6EP3331-7SB00-0AX0	6EP3332-7SB00-0AX0	6EP3323-7SB00-0AX0	6EP3333-7LB00-0AX0	6EP3333-7SB00-0AX0
Rated input voltage	120–230 V AC/120–240 V DC			120–230 V AC/120–240 V DC		
– Range	85–264 V AC/110–275 V DC			85–264 V AC/99–275 V DC		
Mains buffering	150 ms at U <sub>in</sub> = 230 V	150 ms at U <sub>in</sub> = 230 V	150 ms at U <sub>in</sub> = 230 V	90 ms at U <sub>in</sub> = 230 V	90 ms at U <sub>in</sub> = 230 V	80 ms at U <sub>in</sub> = 230 V
Rated line frequency	50/60 Hz	50/60 Hz	50/60 Hz	50/60 Hz	50/60 Hz	50/60 Hz
Rated input current	0.5/0.3 A	0.6/0.3 A	1.1/0.6 A	1.4/0.8 A	1.5/0.9 A	1.9/1.1 A
– Inrush current <sup>1)</sup>	< 32 A	< 32 A	< 32 A	< 29 A	< 29 A	< 29 A
– Recom. miniature circuit breaker	from 6 A characteristic C	from 6 A characteristic C	from 6 A characteristic C	from 6 A characteristic C	from 6 A characteristic C	from 6 A characteristic C
Rated output voltage	12 V	24 V	24 V	12 V	24 V	24 V
– Tolerance	± 3%	± 3%	± 3%	± 3%	± 3%	± 3%
– Setting range	10.5–12.9 V	22.2–26.4 V	22.2–26.4 V	12–15.5 V	24–28 V	24–28 V
Rated output current	2 A	1.3 A	2.5 A	7 A	3.7 A	5 A
– Permanently up to +45 °C	2 A	1.3 A	2.5 A	8.4 A	3.7 A	6 A
– Overload behavior (extra power for 5 s/min)	–	–	–	150%	–	150%
– Derating	–	from +60 °C (2.5%/K)	from +60 °C (1.5%/K)	from +60 °C (2%/K)	–	from +60 °C (2%/K)
Efficiency at rated values, approx.	83.3%	86.3%	89%	87.1%	89.3%	90.2%
Signaling contact	No	No	No	DC o.k.	DC o.k.	DC o.k.
Parallel switching	No	No	No	No	No	No
Electronic short-circuit protection	Yes, restart	Yes, restart	Yes, restart	Yes, constant current (< 9 V hiccup)	Yes, constant current (< 15 V hiccup)	Yes, constant current (< 15 V hiccup)
Radio interfer. suppression (EN 55022)	Class B	Class B	Class B	Class B	Class B	Class B
Supply harmonics limitation (EN 61000-3-2)	Not applicable	Not applicable	Not applicable	Yes	Yes	Yes
Degree of protection (EN 60529)	IP 20	IP 20	IP 20	IP 20	IP 20	IP 20
Ambient temperature	Operation –25...+70 °C, startup from –40 °C					
Dimensions (W x H x D) in mm	25 x 100 x 88	25 x 100 x 88	40 x 100 x 88	35 x 135 x 125	35 x 135 x 125	35 x 135 x 125
Weight approx.	0.2 kg	0.2 kg	0.25 kg	0.7 kg	0.7 kg	0.7 kg
Certification	CE, cULus, cCSAus, CB, SEMI F47, 24 V/3,7 A: NEC Class 2; in preparation: DNV GL, ABS					

<sup>1)</sup>Inrush current can be limited by means of a SITOP inrush current limiter: Article no. 6EP4683-6LB00-0AY0 (max. 5 A, 100–240 V AC) or 6EP1967-2AA00 (max. 10 A, 100–480 V AC) 1 unit per phase required <sup>2)</sup> or 3RV2011-1EA10 or 3RV2711-1ED10  
 Technical data applies at rated input voltage and ambient temperature of +25°C (unless otherwise specified)

new!				new!		
SITOP PSU6200 1-phase				SITOP PSU6200 3-phase		
						
<b>12 V/12 A, PSU6200</b>	<b>24 V/10 A, PSU6200</b>	<b>48 V/5 A, PSU6200</b>	<b>24 V/20 A, PSU6200</b>	<b>24 V/5 A, PSU6200</b>	<b>24 V/10 A, PSU6200</b>	<b>24 V/20 A, PSU6200</b>
6EP3324-7SB00-3AX0	6EP3334-7SB00-3AX0	6EP3344-7SB00-3AX0	6EP3336-7SB00-3AX0	6EP3433-7SB00-0AX0	6EP3434-7SB00-3AX0	6EP3436-7SB00-3AX0
120–230 V AC/110–240 V DC				400–500 V 3 AC		
85–264 V AC/85–275 V DC				323 ... 576 V 3 AC/450...600 V DC		
70 ms at Uin = 230 V	45 ms at Uin = 230 V	46 ms at Uin = 230 V	25 ms at Uin = 230 V	20 ms at Uin = 400 V	30 ms at Uin = 400 V	25 ms at Uin = 400 V
50/60 Hz	50/60 Hz	50/60 Hz	50/60 Hz	50/60 Hz	50/60 Hz	50/60 Hz
1.4/0.8 A	2.2/1.2 A	2.2/1.2 A	4.3/2.3 A	0.33/0.28 A	0.39/0.32 A	0.77/0.62 A
< 6 A	< 6 A	< 6 A	< 12 A	< 22 A	< 13 A	< 17 A
from 6 A characteristic C	from 10 A characteristic C	from 10 A characteristic C	from 10 A characteristic C	4...10 A char. C 3-ph. coupled <sup>2)</sup>	4...16 A characteristic C 3-ph. coupled <sup>2)</sup>	
12 V	24 V	48 V	24 V	24 V	24 V	24 V
± 3%	± 3%	± 3%	± 3%	± 3%	± 3%	± 3%
12–15.5 V	24–28 V	48–56 V	24–28 V	24–28 V	24–28 V	24–28 V
12 A	10 A	5 A	20 A	5 A	10 A	20 A
14.4 A	12 A	6 A	24 A	6 A	12 A	24 A
150%	150%	150%	150%	150%	150%	150%
from +60 °C (2%/K)	from +60 °C (2%/K)	from +60 °C (3%/K)	from +60 °C (1%/K)	from +60 °C (3%/K)	from +60 °C (3%/K)	from +60 °C (3%/K)
89.3%	92.8%	93.9%	95.5%	91.2%	95.4%	95.9%
DC o.k./Diagnose	DC o.k./Diagnose	DC o.k./Diagnose	DC o.k./Diagnose	DC o.k.	DC o.k./Diagnose	DC o.k./Diagnose
Yes, 2 units	Yes, 2 units	Yes, 2 units	Yes, 2 units	No	Yes, 2 units	Yes, 2 units
Yes, constant current (< 9 V hiccup)	Yes, constant current (< 15 V hiccup)	Yes, constant current (< 30 V hiccup)	Yes, constant current (< 15 V hiccup)	Yes, constant current (< 15 V hiccup)	Yes, constant current (< 15 V hiccup)	Yes, constant current (< 15 V hiccup)
Class B	Class B	Class B	Class B	Class B	Class B	Class B
Yes	Yes	yes	Yes	Yes	Yes	Yes
IP 20	IP 20	IP 20	IP 20	IP 20	IP 20	IP 20
Operation –25...+70 °C, startup from –40 °C						
45 x 135 x 125	45 x 135 x 125	45 x 135 x 125	70 x 135 x 155	35 x 135 x 125	45 x 135 x 155	70 x 135 x 155
0.9 kg	0.9 kg	0.9 kg	1.5 kg	0.7 kg	0.9 kg	1.5 kg
CE, cULus, cCSAus, CB, SEMI F47, in preparation: DNV GL, ABS				CE, cULus, SEMI F47, in preparation: DNV GL, ABS		

# SITOP smart standard power supplies

## The high-performance standard power supply



Technical data	SITOP smart 1-phase					
Output voltage/current, type	24 V/2.5 A, PSU100S	24 V/5 A, PSU100S	12 V/7 A, PSU100S	24 V/10 A, PSU100S	12 V/14 A, PSU100S	24 V/20 A, PSU100S
Article No.	6EP1332-2BA20	6EP1333-2BA20	6EP1322-2BA00	6EP1334-2BA20	6EP1323-2BA00	6EP1336-2BA10
Rated input voltage	120/230 V AC	120/230 V AC	120/230 V AC	120/230 V AC	120/230 V AC	120/230 V AC
– Range	85...132/170...264 V AC, automatic range switching					
Mains buffering	> 20 ms (at 93/187 V)	> 20 ms (at 93/187 V)	> 20 ms (at 93/187 V)	> 20 ms (at 93/187 V)	> 20 ms (at 93/187 V)	> 20 ms (at 120/230 V)
Rated line frequency	50/60 Hz	50/60 Hz	50/60 Hz	50/60 Hz	50/60 Hz	50/60 Hz
Rated input current	1.25 A/0.74 A	2.34 A/1.36 A	1.73 A/0.99 A	4.49 A/1.91 A	3.24 A/1.41 A	7.5/3.5 A
– Inrush current <sup>1)</sup>	< 33 A	< 40 A	< 45 A	< 60 A	< 60 A	< 11 A
– Recommended miniature circuit breaker	from 3 A characteristic C	from 6 A characteristic C	from 6 A characteristic C	from 10 A characteristic C	from 10 A characteristic C	from 10 A characteristic C
Rated output current	24 V DC	24 V DC	12 V DC	24 V DC	12 V DC	24 V DC
– Tolerance	± 3 %	± 3 %	± 3 %	± 3 %	± 3 %	± 3 %
– Setting range	22.8...28 V DC	22.8...28 V DC	11.5...15.5 V DC	22.8...28 V DC	11.5...15.5 V DC	24...28 V DC
Rated output current	2.5 A	5 A	7 A	10 A	14 A	20 A
– Permanently up to +45 °C	3 A	6 A	7 A	12 A	14 A	24 A
– Overload behavior (extra power for 5 s/min)	3.75 A	7.5 A	10.5 A	15 A	21 A	30 A
– Derating	from +60 °C (3%/K)	from +60 °C (3%/K)	from +55 °C (5%/K)	from +60 °C (3%/K)	from +55 °C (5%/K)	from +60 °C (5%/K)
Efficiency at rated values, approx.	85 %	88 %	84 %	90 %	87 %	90 %
Signaling contact "DC o. k."	Yes	Yes	Yes	Yes	Yes	Yes
Parallel switching	Yes	Yes	Yes	Yes	Yes	Yes
Elec. short-circuit protection	Yes, constant current	Yes, constant current	Yes, constant current	Yes, constant current	Yes, constant current	Yes, restart
Radio int. sup. (EN 55022)	Class B	Class B	Class B	Class B	Class B	Class B
Supply harmonics limitation (EN 61000-3-2)	Not applicable	Yes	Yes	Yes	Yes	Yes
Degree of protection (EN 60529)	IP20	IP20	IP20	IP20	IP20	IP20
Ambient temperature	–25...+70 °C	–25...+70 °C	–25...+70 °C	–25...+70 °C	–25...+70 °C	–25...+70 °C
Dimensions (W x H x D) in mm	32.5 x 125 x 120	50 x 125 x 120	50 x 125 x 120	70 x 125 x 120	70 x 125 x 120	115 x 145 x 150
Weight approx.	0.32 kg	0.5 kg	0.5 kg	0.8 kg	0.8 kg	2.4 kg
Certification	CE, cULus, CB, ATEX, IECEx, cCSAus Class I Div 2, DNV GL, BV	CE, cULus, CB, ATEX, IECEx, cCSAus Class I Div 2, DNV GL, BV	CE, cULus, CB, ATEX, IECEx, cCSAus Class I Div 2, DNV GL	CE, cULus, CB, ATEX, IECEx, cCSAus Class I Div 2, DNV GL, BV	CE, cULus, CB, ATEX, IECEx, cCSAus Class I Div 2, DNV GL	CE, cULus, CB, ATEX, IECEx, cCSAus Class I Div 2, DNV GL

<sup>1)</sup> Inrush current can be limited by a SITOP inrush current limiter: 6EP4683-6LB00-0AY0 (max. 5 A, 100–240 V AC) or 6EP1967-2AA00 (max. 10 A, 100–480 V AC, 3 units required for 3 phases)  
 Technical data applies at rated input voltage and ambient temperature of +25°C (unless otherwise specified).



### SITOP smart 3-phase

24 V/5 A, PSU300S	24 V/10 A, PSU300S	24 V/20 A, PSU300S	24 V/40 A, PSU300S
6EP1433-2BA20	6EP1434-2BA20	6EP1436-2BA10	6EP1437-2BA20
400–500 V 3 AC	400–500 V 3 AC	400–500 V 3 AC	400–500 V 3 AC
340...550 V 3 AC	340...550 V 3 AC	340...550 V 3 AC	340...550 V 3 AC
> 6 ms (at 400 V)	> 6 ms (at 400 V)	> 6 ms (at 400 V)	> 6 ms (at 400 V)
50/60 Hz	50/60 Hz	50/60 Hz	50/60 Hz
0.45–0.4 A < 40 A 6–16 A charact. C 3-ph. coupled or 3RV2011-1DA10 or 3RV2711-1DD10	0.7–0.6 A < 50 A 6–16 A charact. C 3-ph. coupled or 3 RV2011-1DA10 or 3 RV2711-1DD10	1.2–1.0 A < 36 A 6–16 A charact. C 3-ph. coupled or 3 RV2011-1DA10 or 3 RV2711-1DD10	2.0–1.5 A < 60 A 10–16 A charact. C 3-ph. coupled or 3 RV2011-1DA10 or 3 RV2711-1DD10
24 V DC ± 3 % 24...28 V DC	24 V DC ± 3 % 24...28 V DC	24 V DC ± 3 % 24...28 V DC	24 V DC ± 3 % 24...28 V DC
5 A 6 A 7.5 A	10 A 12 A 15 A	20 A 24 A 30 A	40 A 48 A 60 A
from +60 °C (3%/K)	from +60 °C (3%/K)	from +60 °C (5%/K)	from +60 °C (2.5%/K)
89 %	91 %	91 %	91.5 %
Yes	Yes	Yes	Yes
Yes	Yes	Yes	Yes
Yes, constant current	Yes, constant current	Yes, restart	Yes, restart
Class B	Class B	Class B	Class B
Yes	Yes	Yes	Yes
IP20	IP20	IP20	IP20
–25...+70 °C	–25...+70 °C	0...+70 °C	0...+70 °C
50 x 125 x 120	70 x 125 x 120	90 x 145 x 150	150 x 145 x 150
0.43 kg	0.67 kg	1.6 kg	3.7 kg
CE, cULus, CB, ATEX, UL Class I Div 2, IECEx, DNV GL, ABS	CE, cULus, CB, ATEX, UL Class I Div 2, IECEx, DNV GL, ABS	CE, cULus, CB, ATEX, UL Class I Div 2, IECEx, DNV GL, ABS	CE, cULus, CB, ATEX, cCSAus Class I Div 2, IECEx, DNV GL, ABS

# LOGO!Power basic power supplies

## Flat power supply for distribution boards



Technical data	18-mm design		36-mm design			
Output voltage/current	12 V/0.9 A	24 V/0.6 A	5 V/3 A	12 V/1.9 A	15 V/1.9 A	24 V/1.3 A
NEC Class 2	Yes	Yes	Yes	Yes	Yes	Yes
Article No.	6EP3320-6SB00-0AY0	6EP3330-6SB00-0AY0	6EP3310-6SB00-0AY0	6EP3321-6SB00-0AY0	6EP3321-6SB10-0AY0	6EP3331-6SB00-0AY0
Rated input voltage – Range	100–240 V AC 85...264 V AC/110...300 V DC		100–240 V AC 85...264 V AC/110...300 V DC			
Mains buffering	> 40 ms (at 187 V)	> 40 ms (at 187 V)	> 40 ms (at 187 V)			
Rated line frequency	50/60 Hz	50/60 Hz	50/60 Hz			
Rated input current – Inrush current <sup>1)</sup> – Recommended miniature circuit breaker	0.3–0.2 A < 20 A from 6 A characteristic B or from 2 A characteristic C	0.3–0.2 A < 20 A	0.36–0.22 A < 26 A from 6 A characteristic B or from 2 A characteristic C	0.53–0.30 A < 25 A	0.63–0.33 A < 25 A	0.70–0.35 A < 25 A
Rated output voltage – Tolerance – Setting range	12 V DC ± 3 % None	24 V DC	5 V DC ± 3 % 4.6...5.4 V DC	12 V DC 10.5...16.1 V DC	15 V DC 10.5...16.1 V DC	24 V DC 22.2...26.4 V DC
Rated output current – Overload behavior on startup – Derating	0.9 A 1.35 A (for 200 ms)	0.6 A 0.9 A (for 200 ms)	3.0 A 4.5 A (for 200 ms) from +55 °C (2%/K)	1.9 A 2.85 A (for 200 ms) from +55 °C (2%/K)	1.9 A 2.85 A (for 200 ms) from +55 °C (2%/K)	1.3 A 1.95 A (for 200 ms) from +55 °C (2%/K)
Efficiency at rated values, approx.	78 %	81 %	76 %	81 %	83 %	86 %
Signaling contact "DC o. k."	No		No	No	No	No
Parallel switching	No	No	Yes	Yes	Yes	Yes
No-load loss	< 0.3 W		< 0.3 W			
Electronic short-circuit protection	Yes, constant current		Yes, constant current			
Radio interference suppression (EN 55022)	Class B		Class B			
Supply harmonics limitation (EN 61000-3-2)	Not applicable		Not applicable			
Degree of protection (EN 60529)	IP20		IP20			
Ambient temperature	–25... +70 °C		–25... +70 °C			
Dimensions (W x H x D) in mm	18 x 90 x 53		36 x 90 x 53			
Weight approx.	0.07 kg	0.07 kg	0.12 kg			
Certification	CE, CB Scheme, cULus, cURus, NEC Class 2, ATEX, IECEx, Class 1 Div 2, FM, SEMI F47, DNV GL, ABS, EAC		CE, CB Scheme, cULus, cURus, NEC Class 2, ATEX, IECEx, Class 1 Div 2, FM, SEMI F47, DNV GL, ABS, EAC		CE, CB Scheme, cULus, cURus, NEC Class 2, ATEX, IECEx, Class 1 Div 2, FM, SEMI F47, DNV GL, ABS, EAC	

<sup>1)</sup> Inrush current can be limited by the SITOP LOGO! ICL 230 inrush current limiter: 6EP4683-6LB00-0AY0 (max. 5 A, 100–240 V AC)  
Specifications at rated input voltage and ambient temperature +25 °C (unless otherwise specified)



Technical data	72-mm design				72-mm design
<b>Output voltage/current</b>	<b>5 V/6.3 A</b>	<b>12 V/4.5 A</b>	<b>15 V/4 A</b>	<b>24 V/2.5 A</b>	<b>24 V/4 A</b>
NEC Class 2	no	no	yes	yes	no
Article No.	6EP3311-6SB00-0AY0	6EP3322-6SB00-0AY0	6EP3322-6SB10-0AY0	6EP3332-6SB00-0AY0	6EP3333-6SB00-0AY0
Rated input voltage	100–240 V AC				100–240 V AC
– Range	85...264 V AC/110...300 V DC				85...264 V AC/110...300 V DC
Mains buffering	> 40 ms (at 187 V)				> 40 ms (at 187 V)
Rated line frequency	50/60 Hz				50/60 Hz
Rated input current	0.71–0.37 A	1.13–0.61 A	1.24–0.68 A	1.22–0.66 A	1.95–0.97 A
– Inrush current <sup>1)</sup>	< 50 A	< 50 A	< 55 A	< 52 A	< 31 A
– Recommended miniature circuit breaker	from 10 A characteristic B or from 6 A characteristic C				from 10 A characteristic B or from 6 A characteristic C
Rated output voltage	5 V DC	12 V DC	15 V DC	24 V DC	24 V DC
– Tolerance	± 3 %				± 3 %
– Setting range	4.6...5.4 V DC	10.5...16.1 V DC	10.5...16.1 V DC	22.2...26.4 V DC	22.2...26.4 V DC
Rated output current	6.3 A	4.5 A	4.0 A	2.5 A	4.0 A
– Overload behavior on startup	9.45 A (for 200 ms)	6.75 A (for 200 ms)	6.0 A (for 200 ms)	3.75 A (for 200 ms)	6.0 A (for 200 ms)
– Derating	from +55 °C (2%/K)	from +55 °C (2%/K)	from +55 °C (2%/K)	from +55 °C (2%/K)	from +55 °C (2%/K)
Efficiency at rated values, approx.	80 %	87 %	88 %	90 %	89 %
Signaling contact "DC o. k."	No	No	No	No	No
Parallel switching	Yes	Yes	Yes	Yes	Yes
No-load loss	< 0.3 W				< 0.3 W
Electronic short-circuit protection	Yes, constant current				Yes, constant current
Radio interference suppression (EN 55022)	Class B				Class B
Supply harmonics limitation (EN 61000-3-2)	Not applicable				Yes
Degree of protection (EN 60529)	IP20				IP20
Ambient temperature	–25... +70 °C				–25... +70 °C
Dimensions (W x H x D) in mm	54 x 90 x 53				72 x 90 x 53
Weight approx.	0.2 kg				0.29 kg
Certification	CE, CB Scheme, cULus, cURus, ATEX, IECEx, Class 1 Div 2, FM, SEMI F47, DNV GL, ABS, EAC	CE, CB Scheme, cULus, cURus, NEC Class 2, ATEX, IECEx, Class 1 Div 2, FM, SEMI F47, DNV GL, ABS, EAC	CE, CB Scheme, cULus, cURus, NEC Class 2, ATEX, IECEx, Class 1 Div 2, FM, SEMI F47, DNV GL, ABS, EAC	CE, CB Scheme, cULus, cURus, NEC Class 2, ATEX, IECEx, Class 1 Div 2, FM, SEMI F47, DNV GL, ABS, BV, LRS, EAC	CE, CB Scheme, cULus, cURus, ATEX, IECEx, Class 1 Div 2, FM, DNV GL, ABS, SEMI F47, BV, LRS, EAC

# SITOP lite basic power supplies

## The cost-effective basic power supply











Technical data	SITOP lite			
<b>Output voltage / current, type</b>	<b>24 V/2.5 A, PSU100L</b>	<b>24 V/5 A, PSU100L</b>	<b>24 V/10 A, PSU100L</b>	<b>24 V/20 A, PSU100L</b>
Article No.	6EP1332-1LB00	6EP1333-1LB00	6EP1334-1LB00	6EP1336-1LB00
Rated input voltage – Range	120/230 V AC 93...132/187...264 V AC	120/230 V AC 93...132/187...264 V AC	120/230 V AC 93...132/187...264 V AC	100–240 V AC 85...264 V AC/88...370 V DC
Mains buffering	> 20 ms (at 93/187 V)	> 20 ms (at 93/187 V)	> 20 ms (at 93/187 V)	> 20 ms (at 93/187 V)
Rated line frequency	50/60 Hz	50/60 Hz	50/60 Hz	50/60 Hz
Rated input current – Inrush current <sup>1)</sup> – Recommended miniature circuit breaker	1.0/0.65 A < 27 A 3 A characteristic C	2.1/1.15 A < 32 A 6 A characteristic C	4.3/2.0 A < 65 A 10 A characteristic C	5.55/2.35 A < 45 A 10 A characteristic C
Rated output voltage – Tolerance – Setting range	24 V DC ± 3 % 22.8...26.4 V DC	24 V DC ± 3 % 22.8...26.4 V DC	24 V DC ± 3 % 22.8...26.4 V DC	24 V DC ± 3 % 22.8...28 V DC
Rated output current – Derating	2.5 A from +45 °C (1.5%/K)	5 A from +45 °C (1.5%/K)	10 A from +45 °C (2%/K)	20 A from +45 °C (2.5%/K)
Efficiency at rated values, approx.	85 %	86 %	89 %	92 %
Signaling contact "DC o. k."	No	No	No	No
Parallel switching	Yes	Yes	Yes	Yes
Electronic short-circuit protection	Yes, constant current	Yes, constant current	Yes, constant current	Yes, constant current
Radio int. sup. (EN 55022)	Class A	Class A	Class A	Class B
Supply harmonics limitation (EN 61000-3-2)	Not applicable	No	No	Yes
Degree of protection (EN 60529)	IP20	IP20	IP20	IP20
Ambient temperature	0... +60 °C	0... +60 °C	0... +60 °C	–25... +70 °C
Dimensions (W x H x D) in mm	32.5 x 125 x 120	50 x 125 x 120	70 x 125 x 120	110 x 125 x 125
Weight approx.	0.4 kg	0.5 kg	0.75 kg	1.8 kg
Certification	CE, cULus, CB-Scheme	CE, cULus, CB-Scheme	CE, cULus, CB-Scheme	CE, cULus, CB-Scheme

<sup>1)</sup> Inrush current can be limited by a SITOP inrush current limiter: 6EP4683-6LB00-0AY0 (max. 5 A, 100–240 V AC) or 6EP1967-2AA00 (max. 10 A, 100–480 V AC)  
Specifications at rated input voltage and ambient temperature +25 °C (unless otherwise specified)





# SITOP in SIMATIC design

									
Technical data	SIMATIC S7-1200 design		SIMATIC S7-300 design		SIMATIC S7-1500 design		SIMATIC ET 200SP PS		SIMATIC ET 200pro design
<b>Output voltage/current, type</b>	<b>24 V/2.5 A, PM1207</b>	<b>24 V/2 A, PS307</b>	<b>24 V/5 A, PS307</b>	<b>24 V/10 A, PS307</b>	<b>24 V/3 A, PM1507</b>	<b>24 V/8 A, PM1507</b>	<b>24 V/5 A, PS</b>	<b>24 V/10 A, PS</b>	<b>24 V/8 A, ET 200pro PS</b>
Article No.	6EP1332-1SH71	6ES7307-1BA01-0AA0	6ES7307-1EA01-0AA0	6ES7307-1KA02-0AA0	6EP1332-4BA00	6EP1333-4BA00	6EP7133-6AB00-OBNO	6EP7133-6AE00-OBNO	6ES7148-4PC00-0HA0
Rated input voltage	120/230 V AC, automatic range selection				85...132/176...264 V AC		85...132/170...264 V AC		380–480 V 3 AC
– Range	85...132/176...264 V AC		85...132/170...264 V AC						340...550 V 3 AC
Mains buffering	> 20 ms (at 93/187 V)								3 ms (at 400 V)
Rated line frequency	50/60 Hz								
Rated input current	1.2/0.67 A	0.9/0.5 A	2.3/1.2 A	4.2/1.9 A	1.4 A/0.8 A	3.7 A/1.7 A	2.3/ 1.4 A	4.5/1.9 A	1 A
– Inrush current <sup>1)</sup>	< 13 A	< 22 A	< 20 A	< 55 A	< 23 A	< 67 A	< 40 A	< 60 A	< 40 A
– Recommended miniature circuit breaker	16 A charact. B, 10 A charact. C	3 A charact. C	6 A charact. C	10 A charact. C	from 6 A charact. C, from 10 A charact. B	from 10 A charact. C, from 16 A charact. B	6 A charact. C	10 A charact. C	3RV2021-4NA10
Rated output voltage	24 V DC	24 V DC	24 V DC	24 V DC	24 V DC	24 V DC	24 V DC	24 V DC	24 V DC
– Tolerance	± 3%	± 3%	± 3%	± 3%	± 3%	± 3%	± 3%	± 3%	– 5%/+3%
– Setting range	–	–	–	–	–	–	22.8...28 V DC	22.8...28 V DC	–
– On/off switch	No	Yes	Yes	Yes	Yes	Yes	Yes	Yes	No
Rated output current	2.5 A	2 A	5 A	10 A	3 A	8 A	5 A	10 A	8 A
– Overload behavior (Extra Power for 5 s/min)	–	–	–	–	4.5 A	12 A	7.5 A	15 A	–
Efficiency at rated values, approx.	83%	84%	87%	90%	87%	90%	88%	90%	88%
Signaling contact "DC o. k."	No	No	No	No	No	No	Yes	Yes	Yes, and for overtemperature
Parallel switching	Yes	Yes	Yes	Yes	Yes	Yes	Yes	Yes	No
Electronic short-circuit protection	Yes, constant current characteristic	Yes, restart	Yes, restart	Yes, restart	Yes, restart	Yes, restart	Yes, constant current characteristic	Yes, constant current characteristic	Yes, restart
Radio interference suppression (EN 55022)	Class B	Class B	Class B	Class B	Class B	Class B	Class B	Class B	EN 61000-6-4 (Class A)
Supply harmonics limitation (EN 61000-3-2)	Not applicable	Not applicable	Yes	Yes	Not applicable	Yes	Yes	Yes	No
Degree of protection (EN 60529)	IP20	IP20	IP20	IP20	IP20	IP20	IP20	IP20	IP67, UL: encl. type 5 indoor
Ambient temperature	0...+60 °C	0...+60 °C	0...+60 °C	0...+60 °C	0...+60 °C	0...+60 °C	–30...+70 °C	–30...+70 °C	–25...+55 °C
Installation	DIN rail or wall mounting	Can be mounted on S7 rail; mounting adapter for DIN rail 35 x 15 mm: 6EP1971-1BA00			on S7-1500 system carrier	on S7-1500 system carrier	DIN rail		Screw mounting, e.g., on ET 200pro system rail
Dimensions (W x H x D) in mm	70 x 100 x 75	40 x 125 x 120	60 x 125 x 120	80 x 125 x 120	50 x 147 x 135	75 x 147 x 135	160 x 117 x 75		310 x 135.5 x 90
Weight approx.	0.3 kg	0.4 kg	0.6 kg	0.8 kg	0.45 kg	0.74 kg	0.5 kg	0.8 kg	2.8 kg
Certification	CE, cULus, CB, FM, ATEX, cCSAus Class I Div 2, DNV GL, ABS	CE, cULus, ATEX, cULus Class I Div 2, DNV GL, ABS			CE, cULus, CB, ATEX, IECEx, cULus Class I Div 2, FM, DNV GL, ABS, BV		CE, cULus, CSA/UL, ABS, DNV GL, FM		CE, cULus508

<sup>1)</sup>Inrush current can be limited by a SITOP inrush current limiter: 6EP4683-6LB00-0AY0 (max. 5 A, 100–240 V AC) or 6EP1967-2AA00 (max. 10 A, 100–480 V AC, 1 unit per phase required).

Technical data applies at rated input voltage and ambient temperature of +25°C (unless otherwise specified)

# DC/DC converter

Areas of application for DC/DC converters			
Typical voltage	12 – 60 V DC	110 – 220 V DC	600 – 900 V DC
Applications	Battery power, DC refreshing, galvanic isolation	Supply voltage	DC link converter
Industries, areas of application	Automated guided vehicles, ships	Power plants	Machine tools, wind energy plants
			
Suiting product line SITOP:	PSU3400	PSU3600 PSU6200 PSU8600 LOGO!Power PSU8200 Lite	PSU400M

Summary table of SITOP DC/DC converters and power supply units with DC input												
SITOP	PSU3400			PSU3600	PSU6200			PSU8600	LOGO!Power	PSU8200	Lite	PSU400M
DC input voltage range	9...18 V	14...32 V	28...60 V	88...250 V	85...275 V	99...275 V	110...275 V	93...275 V	110...300 V	88...350 V	88...370 V	300...900 V
Rated output voltage/current												
5 V									3 A, 6.3 A			
12 V		8 A, 15 A		dual 3.5 A (2x12...28 V)	12 A	7 A	2 A		0.9 A, 1.9 A, 4.5 A			
15 V									1.9 A, 4 A			
24 V	4 A	5 A, 10 A	3.5 A, 5 A, 10 A		10 A, 20 A	3.7 A, 5 A	1.3 A, 2.5 A		0.6 A, 1.3 A, 2.5 A, 4 A	20 A	20 A	20 A
4...28 V								4 x 5 A				
48 V					5 A							
0...52 V				flexi 10 A								

# DC/DC converter



DC/DC converter									
Technical data	24 V/4 A, PSU3400	12 V/8 A, PSU3400	24 V/5 A, PSU3400	12 V/15 A, PSU3400	24 V/10 A, PSU3400	24 V/3,5 A NEC Class 2, PSU3400	24 V/5 A, PSU3400	24 V/10 A, PSU3400	24 V/20 A, PSU400M
Article No.	6EP3133-0TA10-0AY0	6EP3123-0TA00-0AY0	6EP3133-0TA00-0AY0	6EP3124-0TA00-0AY0	6EP3134-0TA00-0AY0	6EP3233-0TA10-0AY0	6EP3233-0TA00-0AY0	6EP3234-0TA00-0AY0	6EP1536-3AA00
Rated input voltage	12 V DC	24 V DC	24 V DC	24 V DC	24 V DC	48 V DC	48 V DC	48 V DC	600 V DC <sup>1)</sup>
– Range	9...18 V DC	18...32 V DC, 14...18 V DC, short-term with derating possible	14...32 V DC, derating for 14...18 V DC	14...32 V DC, derating for 14...18 V DC	24...60 V DC, startup from 36 V, derating for 28–36 V	28...60 V DC, startup from 36 V, derating for 28–36 V	28...60 V DC, startup from 36 V, derating for 28–36 V	28...60 V DC, startup from 36 V, derating for 28–36 V	300...900 V DC, startup from approx. 340 V
Mains buffering	> 2 ms	> 5 ms	> 5 ms	> 5 ms	> 5 ms	> 5 ms	> 5 ms	> 5 ms	–
Rated input current	9.0 A	4.5 A	5.5 A	8.4 A	10.8 A	1.9 A	2.7 A	5.4 A	0.85 A
– Inrush current	<15 A	<15 A	<15 A	<15 A	<15 A	<15 A	<15 A	<15 A	<8 A
– Recommended miniature circuit breaker (not necessary in case of feed-in by SITOP)	16 A characteristic B or C	10 A characteristic B or C	16 A characteristic B or C	16 A characteristic B or C	10 A characteristic B or C	10 A characteristic B or C	16 A characteristic B or C	16 A characteristic B or C	–
Rated output voltage	24 V DC	12 V DC	24 V DC	12 V DC	24 V DC	24 V DC	24 V DC	24 V DC	24 V DC
– Tolerance	± 3%	± 3%	± 3%	± 2%	± 1%	± 3%	± 3%	± 1%	± 3%
– Setting range	24...28 V DC	12...15.5 V DC	24...28 V DC	12...15.5 V DC	24...28 V DC	24...28 V DC	24...28 V DC	24...28 V DC	24...28.8 V DC
Rated output current	4 A	8 A	5 A	15 A	10 A	3.5 A	5 A	10 A	20 A
– Overload behavior	–	–	6 A up to 40 °C	–	12 A up to 40 °C	–	6 A up to 40 °C	12 A up to 40 °C	30 A
– Derating	from +60 °C (2%/K)	from +60 °C (2%/K)	from +60 °C (2%/K)	from +60 °C (2%/K)	from +60 °C (2%/K)	–	from +60 °C (2%/K)	from +60 °C (2%/K)	from +60 °C (5.5%/K), 300...400 V DC, 824...900 V DC
Efficiency at rated values, approx.	89%	89.4%	92.5%	91%	93%	90.4%	91.6%	93.5%	95%
Signaling contact "DC o. k."	No	No	No	Yes	Yes	No	No	Yes	Yes
Parallel switching	Yes, 2 units	Yes, 2 units	Yes, 2 units	Yes, 2 units	Yes, 2 units	–	Yes, 2 units	Yes, 2 units	Yes, output line switchable
Electronic short-circuit protection	Yes, restart	–	–	–	–	–	–	–	Yes, constant current or latching shutdown selectable
Radio suppression level (EN 55022)	Class B	Class B	Class B	Class B	Class B	Class B	Class B	Class B	Class A (emission)
Line harmonics limitation (EN 61000-3-2)	Not applicable	Not applicable	Not applicable	Not applicable	Not applicable	Not applicable	Not applicable	Not applicable	No
Degree of protection (EN 60529)	IP20	IP20	IP20	IP20	IP20	IP20	IP20	IP20	IP20
Ambient temperature	–25...+70 °C	–25...+70 °C	–25...+70 °C	–25...+70 °C	–25...+70 °C	–25...+70 °C	–25...+70 °C	–25...+70 °C	–25...+70 °C
Installation	DIN rail	–	–	–	–	–	–	–	–
Dimensions (W x H x D) in mm	32 x 100 x 100	32 x 100 x 100	32 x 100 x 100	42 x 125 x 120	42 x 125 x 120	32 x 100 x 100	32 x 100 x 100	42 x 125 x 120	90 x 125 x 125
Weight approx.	0.4kg	0.4kg	0.4kg	0.6 kg	0.6 kg	0.4kg	0.4kg	0.6kg	1.2 kg
Certification	CE, cULus, ABS, in preparation: DNV GL	CE, cULus, ABS, in preparation: DNV GL	CE, cULus, ABS, in preparation: DNV GL	CE, cULus, ABS, in preparation: DNV GL	CE, cULus, ABS, in preparation: DNV GL	CE, cULus, ABS, in preparation: DNV GL	CE, cULus, ABS, in preparation: DNV GL	CE, cULus, ABS, in preparation: DNV GL	CE, cULus, CB, DNV GL

<sup>1)</sup> The SITOP PSU400M power supply is designed for connection to a DC link power system, which means that the input voltage rises and falls successively while charging the DC link. Hot plug-in and hot plug-out of the input voltage above 450 V is not allowed. The 6EP1566-3AA00 ballast device for limiting the voltage rise must be used for this purpose. Technical data applies at rated input voltage and ambient temperature of +25°C (unless otherwise specified).





# SITOP

## in special designs and applications



Technical data	Wall mounting						
<b>Output voltage/current, type</b>	<b>12 V/3 A, PSU100D</b>	<b>24 V/2,1 A, PSU100D</b>	<b>24 V/3,1 A, PSU100D</b>	<b>24 V/4,1 A, PSU100D</b>	<b>12 V/8,3 A, PSU100D</b>	<b>24 V/6,2 A, PSU100D</b>	<b>24 V/12,5 A, PSU100D</b>
Article No.	6EP1321-1LD00	6EP1331-1LD00	6EP1332-1LD00	6EP1332-1LD10	6EP1322-1LD00	6EP1333-1LD00	6EP1334-1LD00
Rated input voltage	100–240 V AC	100–240 V AC	100–240 V AC	100–240 V AC	100–240 V AC	100–240 V AC	100–240 V AC
– Range	85...264 V AC	85...264 V AC	85...264 V AC	85...264 V AC	85...264 V AC	85...264 V AC	85...264 V AC
Mains buffering	> 15 ms (at 115/230 V)	> 15 ms (at 115/230 V)	> 15 ms (at 115/230 V)	> 15 ms (at 115/230 V)	> 15 ms (at 115/230 V)	> 15 ms (at 115/230 V)	> 15 ms (at 115/230 V)
Rated line frequency	50/60 Hz	50/60 Hz	50/60 Hz	50/60 Hz	50/60 Hz	50/60 Hz	50/60 Hz
Rated input current	0.75–0.5 A	1.1–0.7 A	1.5–1.0 A	2.0–1.1 A	2.0–1.1 A	3.1–2.0 A	4.0–2.0 A
– Inrush current <sup>1)</sup>	< 60 A	< 60 A	< 60 A	< 75 A	< 75 A	< 75 A	< 60 A
– Recommended miniature circuit breaker	10 A characteristic C, 16 A characteristic B						
Rated output voltage	12 V DC	24 V DC	24 V DC	24 V DC	12 V DC	24 V DC	24 V DC
– Tolerance	± 2 %	± 2 %	± 2 %	± 2 %	± 2 %	± 2 %	± 2 %
– Setting range	11...14 V DC	22...28 V DC	22...28 V DC	22...28 V DC	11...14 V DC	22...28 V DC	22...28 V DC
Rated output current	3 A	2.1 A	3.1 A	4.1 A	8.3 A	6.2 A	12.5 A
– Derating	from +50 °C (2.5 %/K)	from +50 °C (2.5 %/K)	from +50 °C (2.5 %/K)	from +50 °C (2.5 %/K)	from +50 °C (2.5 %/K)	from +50 °C (2.5 %/K)	from +50 °C (2.5 %/K)
Efficiency at rated values, approx.	84 %	86 %	86 %	86 %	84 %	86 %	86 %
Signaling contact "DC o. k."	No	No	No	No	No	No	No
Remote On/Off	No	No	No	No	No	No	No
Parallel switching	Yes	Yes	Yes	Yes	Yes	Yes	Yes
Electronic short-circuit protection	Yes, restart	Yes, restart	Yes, restart	Yes, restart	Yes, restart	Yes, restart	Yes, restart
Radio interference suppression (EN 55022)	Class B	Class B	Class B	Class B	Class B	Class B	Class B
Supply harmonics limitation (EN 61000-3-2)	Not applicable	Not applicable	Yes	Yes	Yes	No	Yes
Degree of protection (EN 60529)	IP20	IP20	IP20	IP20	IP20	IP20	IP20
Ambient temperature	–10...+70 °C	–10...+70 °C	–10...+70 °C	–10...+70 °C	–10...+70 °C	–10...+70 °C	–10...+70 °C
Installation	Wall mounting, variable installation position						
Dimensions (W x H x D) in mm	97 x 98 x 38	97 x 128 x 38	97 x 128 x 38	97 x 158 x 38	97 x 158 x 38	97 x 178 x 38	105 x 199 x 41
Weight approx.	0.37 kg	0.35 kg	0.37 kg	0.50 kg	0.57 kg	0.55 kg	0.81 kg
Certification	CE, cULU, cURus	CE, cULus, cURus	CE, cULus, cURus	CE, cULus, cURus	CE, cULus, cURus	CE, cULus, cURus	CE, cULus, cURus

<sup>1)</sup> Inrush current can be limited by a SITOP inrush current limiter: 6EP4683-6LB00-0AY0 (max. 5 A, 100–240 V AC).  
Technical data applies at rated input voltage and ambient temperature of +25°C (unless otherwise specified).

										
Two outputs		Flexible output 0–52 V		High degree of protection		Slim design		Flat design Slim design Power supplies for charging batteries		
<b>2 x 15 V/3,5 A, SITOP PSU3600</b>		<b>3...52 V/10A, SITOP PSU3600</b>		<b>24 V/5 A, PSU100P 24 V/8 A, PSU100P<sup>1)</sup></b>		<b>24 V/5 A, PSU300E 48 V/5 A, PSU100E</b>		<b>12 V/20 A, PSU3800 24 V/17 A, PSU3800 24 V/30 A, 40 A, PSU3800</b>		
6EP3323-0SA00-0BY0		6EP3343-0SA00-0AY0		6EP1333-7CA00 6EP1334-7CA00		6EP1433-0AA00 6EP3344-0SB00-0AY0		6EP3424-8UB00-0AY0 6EP3436-8UB00-0AY0 6EP3437-8UB00-0AY0 <sup>1)</sup>		
120–230 V AC, 110–220 V DC 85...264 V AC, 88...250 V DC		120–230 V AC, 110–220 V DC 85...264 V AC, 88...250 V DC		120/230 V AC, automatic range switching 85... 132/170... 264 V AC		400 V 3 AC 320...480 V 3 AC		120/230 V AC 85...132/170...264 V AC 320...575 V 3 AC		
> 80 ms (at 230 V)		> 80 ms (at 230 V)		> 40 ms (at I <sub>Out rated</sub> ) > 40 ms (at I <sub>Out rated</sub> )		> 50 ms (at 400 V) > 20 ms (at 93/187 V)		> 15 ms (at 400 V) > 15 ms (at 400 V) > 10 ms (at 400 V)		
50/60 Hz		50/60 Hz		50/60 Hz		50/60 Hz		50/60 Hz		
2.2–1.3 A		2.6–1.3 A		2.25 A/1.24 A 3.5 A/1.52 A		0.36 A		0.7–0.6 A		
< 35 A		< 35 A		< 15 A		< 15 A		< 18 A		
6–10 A characteristic C		6–10 A characteristic C		from 6 A charact. C/B from 6 A charact. C/B		6–10 A charact. C 10 A charact. C		6–16 A charact. C 3-ph. coupled or 3RV2011-1DA10 or 3RV2711-1DD10		
2 x 15 V DC		24 V DC		24 V DC		24 V DC		12 V DC		
± 1%		± 1%		± 3%		± 3%		± 3%		
12...28 V DC		0...52 V DC <sup>2)</sup>		–		24...29 V DC		12...14 V DC		
2 x 3.5 A (max. 60 W per output)		2–10 A (max. 120 W)		5 A 8 A		5 A		17 A		
–		–		–		–		–		
88%		88%		90%		93%		94%		
No		Yes, and current monitor		Yes		Yes		Yes		
No		No		No		No		Yes		
Yes		Yes		Yes, two units		Yes, two units		Yes		
Yes, restart Class B		Yes, constant current Class B		Yes, restart Class B		Yes, restart Class A		Yes, constant current or latching shutdown selectable Class B		
Yes		Yes		Yes		Yes		Yes		
IP20		IP20		IP67, UL: enclosure type 4 indoor		IP20		IP20		
–25...+70 °C		–25...+70 °C		–25...+60 °C –25...+60 °C		0...+60 °C		–25...+70 °C		
DIN rail		DIN rail		Screw mounting		DIN rail		DIN rail		
42 x 125 x 125		42 x 125 x 135		120 x 181 x 60,5		42 x 125 x 125		70 x 125 x 125		
0.55 kg		0.55 kg		1.1 kg		1.3 kg		1.2 kg		
CE, cULus, NEC Class 2		CE, cULus		CE, cULus		CE, cULus		CE, cULus, ATEX, cCSAus Class I Div. 2, DNV GL, ABS		
								CE; cULus, CB, ATEX, IECEx, cCSAus Class I Div 2, SEMI F47,		

<sup>1)</sup> Inrush current can be limited by a SITOP inrush current limiter: 6EP4683-6LB00-0AY0 (max. 5 A, 100–240 V AC) or 6EP1967-2AA00 (max. 10 A, 100–480 V AC, 1 unit per phase required).

<sup>2)</sup> Via analog voltage signal 0...2.5 V







Specifications at rated input voltage and ambient temperature +25 °C (unless otherwise specified)

# SITOP expansion modules to increase system availability



Technical data	Redundancy				
SITOP	SITOP RED1200 redundancy module		SITOP PSE202U redundancy module		
Article No.	6EP4346-7RB00-0AX0	6EP4347-7RB00-0AX0	6EP1964-2BA00	6EP1962-2BA00	6EP1961-3BA21
Rated input voltage – Range	12 V, 24 V, 48 V DC 10...58 V DC	12 V, 24 V, 48 V DC 10...58 V DC	24 V DC 19...29 V DC	24 V DC 19...29 V DC	24 V DC 24...28.8 V DC
Brief description of product/function	Module for redundancy mode and for decoupling power supplies with output voltages from 12 to 48 V, e.g. for series connection to increase voltage to up to 96 V or parallel connection of more than 2 power supplies to enhance performance.		Module for redundancy mode; floating relay contact and green LED for signaling “Infeed 1 and 2 o.k.”, switching threshold adjustable between 20 and 25 V DC		
Possible combinations	Decoupling of two 12 V to 48 V power supplies with output currents up to 10 A or one 20-A power supply per redundancy module	Decoupling of two 12 V to 48 V power supplies with output currents up to 20 A or one 40-A power supply per redundancy module	Decoupling of two 24-V power supplies up to 5 A or one 10-A power supply per redundancy module	Decoupling and limitation of the output to Class-2 limit (100 VA) of two 24-V power supplies 5 to 40 A	Decoupling of two 24-V power supplies 5 A to 20 A or one 40-A power supply per redundancy module
Rated output current	20 A (total output current)	40 A (total output current)	10 A (total output current)	3.5 A <sup>1)</sup>	40 A (total output current)
Reverse voltage protection	200 V DC	200 V DC	52 V DC	52 V DC	52 V DC
Efficiency at rated values, approx.	97.5 %	97.5 %	97 %	95 %	97 %
Radio interference suppression (EN 55022)	Class B	Class B	Class B	Class B	Class B
Degree of protection (EN 60529)	IP20	IP20	IP20	IP20	IP20
Terminals	Push-in	Push-in	Screw terminals	Screw terminals	Screw terminals
Ambient temperature	–25...+70 °C	–25...+70 °C	–20...+70 °C	–20...+70 °C	–25...+60 °C
Dimensions (W x H x D) in mm	35 x 135 x 125	45 x 135 x 125	30 x 80 x 100	30 x 80 x 100	70 x 125 x 125
Weight approx.	0.35 kg	0.35 kg	0.125 kg	0.125 kg	0.5 kg
Certification	CE, cULus, CB, ATEX, IECex, in preparation: cCSAus Class1 div2, DNV GL, ABS		CE, cULus	CE, cULus, NEC Class 2	CE, cULus, cCSAus Class I Div 2, ATEX, IECEx, DNV GL, ABS

<sup>1)</sup>Max. 8 A summation current in fault case in accordance with NEC Class 2 Specifications at rated input voltage and ambient temperature +25 °C (unless otherwise specified)

	new!			new!			new!			
										
Technical data	Monitoring									
SITOP	SITOP SEL1200 selectivity module with switching characteristic			SITOP SEL1400 selectivity module with current limiting characteristic			SITOP PSE200U selectivity module with current limiting characteristic and common signaling contact		SITOP PSE200U selectivity module with current limiting characteristic and single-channel signaling	
Article No.	6EP4437-7FB00-3CX0	6EP4437-7FB00-3DX0	6EP4438-7FB00-3DX0	6EP4437-7EB00-3CX0	6EP4437-7EB00-3DX0	6EP4438-7EB00-3DX0	6EP1961-2BA11	6EP1961-2BA21	6EP1961-2BA31	6EP1961-2BA41
Article No. with NEC Class 2							6EP1961-2BA51	6EP1961-2BA61		
Rated input voltage/range	24 V DC/20.4...30 V DC			24 V DC/20.4...30 V DC			24 V DC/22...30 V DC		24 V DC/22...30 V DC	
Brief product description	Module for distributing the 24-V supply over up to four or eight load circuits and their monitoring for overload; selective shutdown of faulty load circuits, rated current individually adjustable; universal use for all power supplies									
Switch-off characteristic	Switching – for standard protection. Release time depending on overcurrent			Current limiting – for increased safeguarding requirements; current limitation to 150 % (110 % for NEC Class 2 variants) of the set threshold value, then shutdown. Voltage dip below 20 V not possible, therefore also suitable for loads that do not meet the PLC standard						
Status indication per output	3-color LED: green – connected, yellow – manually disconnected, red – disconnected due to overcurrent									
Signal outputs	Diagnostics interface for common signaling or single-channel diagnostics. Analysis of single-channel diagnostics via SIMATIC S7 function block: current, set current threshold value, status (on/off), reason for disconnection (if applicable)						Common signaling contact. Voltage measuring points for current value per output (1 V ± 1 A)		Single-channel signaling for channel-specific analysis via SIMATIC S7-function block. Voltage measuring points for current value per output (1 V ± 1 A)	
Reset, outputs switched on/off	Remote reset with 24-V signal. Reset and each output switched on/off via push button									
Individual load circuits switched on sequentially	Load-optimized (previous output less than set rated value) + 25 ms, + 200 ms, or + 500 ms						0 ms (simultaneously), 25 ms, 100 ms or load-optimized (previous output less than set rated value)			
Rated output current	4 x 10 A	8 x 5 A	8 x 10 A	4 x 10 A	8 x 5 A	8 x 10 A	4 x 3 A	4 x 10 A	4 x 3 A	4 x 10 A
– Setting range	2...10 A	1...5 A	2...10 A	2...10 A	1...5 A	2...10 A	0,5...3 A	3...10 A	0,5...3 A	3...10 A
Efficiency at rated values, approx.	typ. 98%	typ. 98%	typ. 98%	typ. 98%	typ. 98%	typ. 98%	97%	99%	97%	99%
Parallel switching of 2 outputs	Yes (max. 15 A)	Yes (max. 7.5 A)	Yes (max. 15 A)	Yes (max. 15 A)	Yes (max. 7.5 A)	Yes (max. 15 A)	No	No	No	No
Electronic short-circuit protection	Yes	Yes	Yes	Yes	Yes	Yes	Yes	Yes	Yes	Yes
Radio interference suppression (EN 55022)	Class B	Class B	Class B	Class B	Class B	Class B	Class B	Class B	Class B	Class B
Degree of protection (EN 60529)	IP20	IP20	IP20	IP20	IP20	IP20	IP20	IP20	IP20	IP20
Terminals	Push-in	Push-in	Push-in	Push-in	Push-in	Push-in	Screw terminals	Screw terminals	Screw terminals	Screw terminals
Ambient temperature	-25...+70 °C	-25...+70 °C	-25...+70 °C	-25...+70 °C	-25...+70 °C	-25...+70 °C	-25...+60 °C	-25...+60 °C	-25...+60 °C	-25...+60 °C
Dimensions (W x H x D) in mm	45 x 135 x 125	45 x 135 x 125	45 x 135 x 125	45 x 135 x 125	45 x 135 x 125	45 x 135 x 125	72 x 80 x 72	72 x 80 x 72	72 x 80 x 72	72 x 80 x 72
Weight approx.	0.3 kg	0.3 kg	0.3 kg	0.3 kg	0.3 kg	0.3 kg	0.2 kg	0.2 kg	0.2 kg	0.2 kg
Certification	CE, UL, cULus, CB, CSA, ATEX, IECEx, in preparation: cCSAus Class I Div 2, GL and ABS						CE, UR, cULus, CB, cCSAus Class I Div 2, ATEX, IECEx, DNV GL, ABS, 6EP1961-2BA51/6EP1961-2BA61: NEC Class 2			

Technical data applies at rated input voltage and ambient temperature of +25°C (unless otherwise specified)

## SITOP expansion modules to increase system availability

## Uninterruptible power supplies – SITOP UPS500 maintenance-free DC UPS with capacitor technology



Technical data	Mains buffering up to the seconds range	Mains buffering up to the minutes range		
SITOP	Buffer module <sup>1)</sup> SITOP PSE201U	UPS500S–basic unit 15 A		UPS501S – expansion module
Buffer time/Energy	200 ms/40 A	2.5 kW <sub>s</sub>	5 kW <sub>s</sub>	5 kW <sub>s</sub>
Article No.	6EP1961-3BA01	6EP1933-2EC41	6EP1933-2EC51	6EP1935-5PG01
Input voltage	24 V DC/24...28.8 V DC	24 V DC, 22...29 V, infeed from SITOP 24 V		Infeed from basic unit
Rated input current	Module for buffering during short power failures; parallel connection at output of 24-V power supplies <sup>1)</sup> . Buffering time 200 ms at 40 A up to 1.6 s at 5 A load current; multiplication possible through parallel connection; maximum buffering time 10 s	15.2 A + approx. 2.3 A in charging mode		Description: expansion module for extending the buffering time, up to three units can be switched in parallel with one UPS500S basic unit
Rated output voltage		In buffer and normal mode 24 V DC ± 3 %		
Rated output current		15 A, charging current 1 A (factory setting) or 2 A selectable		
Efficiency at rated values, approx.		97.5 %		
Overload and short-circuit protection		Electronic, automatic restart		
Parallel switching	Yes	No		Yes, up to three units
Radio interference suppression (EN 55022)	Class B	Class B	Class B	Class B
Degree of protection (EN 60529)	IP20	IP20	IP20	IP20
Ambient temperature	0...+60 °C	0...+60 °C	0...+60 °C	0...+60 °C
Dimensions (W x H x D) in mm	70 x 125 x 125	120 x 125 x 125	120 x 125 x 125	70 x 125 x 125
Weight approx.	1.2 kg	1.0 kg	1.0 kg	0.7 kg
Certification	CE, UL, CSA, ATEX, UL Class I Div 2, DNV GL, ABS	CE, cULus, CB, ATEX, cCSAus Class I Div 2, DNV GL, ABS		

<sup>1)</sup> Can be combined with SITOP PSU8200, PSU6200 and SITOP smart 24-V power supplies (except 6EP1 336-2BA10)  
Specifications at rated input voltage and ambient temperature +25 °C (unless otherwise specified)



# Buffering times and charging times

## SITOP UPS500



SITOP UPS500S/501S configurations

Basic unit	2.5 kW	5 kW	2.5 kW	5 kW	2.5 kW	5 kW	2.5 kW	5 kW
Expansion modules	–	–	1 x 5 kW	1 x 5 kW	2 x 5 kW	2 x 5 kW	3 x 5 kW	3 x 5 kW
Total energy	2.5 kW	5 kW	7.5 kW	10 kW	12.5 kW	15 kW	17.5 kW	20 kW

### Buffering times

Load current								
0.5 A	134 s	236 s	390 s	478 s	632 s	748 s	851 s	1,007 s
0.8 A	90 s	167 s	266 s	346 s	440 s	527 s	580 s	706 s
1 A	75 s	138 s	219 s	296 s	365 s	414 s	490 s	572 s
2 A	38 s	76 s	122 s	156 s	203 s	230 s	265 s	306 s
3 A	26 s	52 s	82 s	106 s	136 s	159 s	186 s	213 s
4 A	19 s	39 s	61 s	81 s	101 s	120 s	139 s	160 s
5 A	15 s	31 s	49 s	65 s	81 s	95 s	111 s	130 s
6 A	12 s	26 s	40 s	55 s	67 s	80 s	94 s	106 s
7 A	10 s	21 s	34 s	47 s	58 s	69 s	81 s	82 s
8 A	8 s	18 s	29 s	40 s	50 s	59 s	69 s	79 s
10 A	6 s	15 s	23 s	32 s	39 s	47 s	54 s	62 s
12 A	4 s	12 s	19 s	26 s	32 s	38 s	44 s	52 s
15 A	3 s	9 s	14 s	20 s	25 s	30 s	35 s	40 s

### Charging times

Charging current								
2 A	54 s	120 s	158 s	223 s	263 s	318 s	355 s	417 s
1 A	110 s	205 s	311 s	425 s	503 s	625 s	695 s	816 s

Specifications at rated input voltage and ambient temperature +25 °C (unless otherwise specified)

# Uninterruptible power supplies





## SITOP DC UPS with battery modules for bridging longer power failures









Technical data	Mains buffering up to the hours range				
SITOP	UPS1600	UPS1600	UPS1600	Battery module UPS1100	Battery module UPS1100
<b>Energy storage</b>				<b>Lead storage batteries</b>	<b>Lead storage batteries</b>
<b>Output voltage/current or charge</b>	<b>24 V/10 A</b>	<b>24 V/20 A</b>	<b>24 V/40 A</b>	<b>24 V/1.2 Ah</b> for UPS1600 10 A	<b>24 V/3.2 Ah</b> for UPS1600 10 A and 20 A
Article No.	6EP4134-3AB00-0AY0	6EP4136-3AB00-0AY0	6EP4137-3AB00-0AY0	6EP4131-0GB00-0AY0	6EP4133-0GB00-0AY0
– with USB interface	6EP4134-3AB00-1AY0	6EP4136-3AB00-1AY0	6EP4137-3AB00-1AY0		
– with Ethernet/PROFINET interface	6EP4134-3AB00-2AY0	6EP4136-3AB00-2AY0	6EP4137-3AB00-2AY0		
Input voltage	24 V DC, 22...29 V, infeed from 24-V SITOP power supply			Recommended end-of-charge voltage (set automatically by SITOP UPS1600)	
Rated input current	approx. 14 A at max. charging current (3 A)	approx. 25 A at max. charging (4 A)	approx. 46 A at max. charging (5 A)	Charging current max. 0.3 A	Charging current max. 0.9 A
Rated output voltage	24 V DC (upstream SITOP device or battery), charging voltage: 27.0 V			24 V DC, 22...27.0 V DC (no-load operation)	
Rated output current	10 A, charging current	20 A, charging current	40 A, charging current max. 5 A	10 A	20 A
– Overload behavior (power boost for 30 ms)	30 A	60 A	120 A		
– Overload behavior (extra power for 5 s/min)	15 A	30 A	60 A		
Efficiency at rated values, approx.	> 97.7%	> 98.2%	> 98.8%	Not applicable	Not applicable
Overload and shortcircuit protection	Yes, restart in normal mode			Installed battery fuse: 15 A/32 V	Installed battery fuse: 25 A/32 V
Parallel switching	No	No	No	Yes, up to six units	Yes, up to six units
Radio interference suppression	Class B (EN 55022)	Class B (EN 55022)	Class B (EN 55022)	–	–
Degree of protection (EN 60529)	IP20	IP20	IP20	IP20	IP20
Ambient temperature (derating from +60 °C)	–25...+70 °C	–25...+70 °C	–25...+70 °C	–15...+50 °C	–15...+50 °C
Installation	DIN rail	DIN rail	DIN rail	DIN rail or wall mounting	DIN rail or wall mounting
Dimensions (W x H x D) in mm	50 x 125 x 125	50 x 125 x 125	70 x 125 x 150	89 x 130 x 107	190 x 169 x 79
Weight approx.	0.38/0.4/0.44 kg	0.39/0.41/0.45 kg	0.65/0.65/0.7 kg	1.9 kg	3.8 kg
Certification	CE, cULus, CB, ATEX, IECEx, cCSAus Class I Div 2, DNV GL, ABS	CE, cULus, CB, ATEX, IECEx, cCSAus Class I Div 2, DNV GL, ABS	CE, cULus, CB, ATEX, IECEx, DNV GL, ABS, cCSAus Class I Div 2	CE, cURus, CB, ATEX, IECEx, cCSAus Class I Div 2, DNV GL, ABS	CE, cURus, CB, ATEX, IECEx, cCSAus Class I Div 2, DNV GL, ABS

Specifications at rated input voltage and ambient temperature +25 °C (unless otherwise specified)

## Battery module selection table: buffer times and service life

Mains buffering up to the hours range			
			
<b>UPS1100 battery module</b>	<b>UPS1100 battery module</b>	<b>UPS1100 battery module with extended temperature range</b>	<b>UPS1100 battery module, lithium technology</b>
<b>Lead batteries</b>	<b>Lead batteries</b>	<b>Pure-lead batteries</b>	<b>LiFePO batteries</b>
<b>24 V/7 Ah</b>	<b>24 V/12 Ah</b>	<b>24 V/2.5 Ah</b>	<b>24 V/5 Ah</b>
for UPS1600 10 A, 20 A, and 40 A	for UPS1600 10 A, 20 A and 40 A	for UPS1600 10 A and 20 A	for UPS1600 10 A and 20 A
6EP4134-0GB00-0AY0	6EP4135-0GB00-0AY0	6EP4132-0GB00-0AY0	6EP4133-0JB00-0AY0
Recommend end-of-charge voltage: set automatically by SITOP UPS1600			
Charging current max. 2.1 A	Charging current max. 3.6 A	Charging current max. 0.7 A	Charging current max. 2.1 A
24 V DC, 22...27.0 V DC (no-load operation)			24 V DC, 22...28.8 V DC (no-load operation)
40 A	40 A	20 A	20 A
Not applicable	Not applicable	Not applicable	Not applicable
Installed battery fuse: 2 x 25 A/32 V	Installed battery fuse: 2 x 25 A/32 V	Installed battery fuse: 25 A/32 V	Installed battery fuse: 25 A/32 V
Yes, up to six units	Yes, up to six units	Yes, up to six units	Yes, up to six units
–	–	–	–
IP20	IP20	IP20	IP20
–15...+50 °C	–15...+50 °C	–40...+60 °C	–20...+50 °C
Wall mounting	Wall mounting	DIN rail or wall mounting	DIN rail or wall mounting
186 x 186 x 110	253 x 186 x 110	265 x 115 x 76	189 x 186 x 113
6.1 kg	9.3 kg	3.7 kg	3.4 kg
CE, cURus, CB, ATEX, IECEx, cCSAus Class I Div 2, DNV GL, ABS	CE, cURus, CB, ATEX, IECEx, cCSAus Class I Div 2, DNV GL, ABS	CE, cURus, CB, ATEX, IECEx, cCSAus Class I Div 2, DNV GL, ABS	CE, cURus, CB, DNV GL, ABS

						
UPS1100 battery module	1.2 Ah	3.2 Ah	7 Ah	12 Ah	2.5 Ah	5 Ah
Load current	Buffering times <sup>1)</sup>					
1 A	27 min	2 h	5 h	8 h 30 min	1 h 30 min	4 h
2 A	14 min	1 h	2 h 40 min	4 h 30 min	50 min	2 h 10 min
3 A	10 min	45 min	1 h 50 min	3 h 10 min	36 min	1 h 30 min
4 A	7 min 50 s	34 min	1 h 20 min	2 h 30 min	26 min	1 h 10 min
6 A	4 min 40 s	21 min	48 min	1 h 30 min	15 min	48 min
8 A	3 min	15 min	34 min	1 h	11 min	37 min
10 A	1 min 30 s	9 min 30 s	21 min	42 min	6 min 40 s	26 min
12 A	–	8 min 10 s	19 min	37 min	5 min 40 s	23 min
14 A	–	6 min 50 s	16 min	32 min	4 min 40 s	21 min
16 A	–	5 min 30 s	13 min	27 min	3 min 40 s	18 min
20 A	–	2 min 50 s	7 min 50 s	17 min	1 min 40 s	13 min
30 A	–	–	3 min 50 s	10 min	3 min 20 s, 2x <sup>2)</sup>	17 min, 2x <sup>2)</sup>
40 A	–	–	1 min 40 s	5 min 30 s	1 min 40 s, 2x <sup>2)</sup>	13 min, 2x <sup>2)</sup>
Ambient temperature	Approximate service life (drop to 80% of the original capacity), depending on battery temperature					
+20 °C	4 years	4 years	4 years	4 years	10 years	15 years
+30 °C	2 years	2 years	2 years	2 years	7 years	10 years
+40 °C	1 year	1 year	1 year	1 year	3 years	9 years
+50 °C	0.5 years	0.5 years	0.5 years	0.5 years	1.5 years	2 years
+60 °C	1 year					

<sup>1)</sup> Buffer time determination is based on the discharging time of new and completely charged battery modules with a minimum battery temperature of +25 °C until DC UPS (19 V) turns off.

The SITOP Selection Tool can be used to determine buffer times for additional temperatures and buffer voltages: [siemens.com/tst-powersupply](https://www.siemens.com/tst-powersupply) <sup>2)</sup> With two parallel connected UPS1100 battery modules and UPS1600 40 A

Find out more:  
[siemens.com/sitop](https://www.siemens.com/sitop)

## Additional information on SITOP:

- › TIA Selection Tool:  
[siemens.com/tst-powersupply](https://www.siemens.com/tst-powersupply)
- › Operating instructions as download:  
[siemens.com/sitop/manuals](https://www.siemens.com/sitop/manuals)
- › Request CAx data via the CAx download manager:  
[siemens.com/cax](https://www.siemens.com/cax)

More  
about  
SITOP on  
YouTube



Subject to changes and errors. The information provided in this brochure contains descriptions or performance characteristics which, in case of actual use, do not always apply as described or which may change as a result of further development of the products. The desired performance characteristics are only binding if expressly agreed in the contract. Availability and technical specifications are subject to change without notice.

All product designations may be trademarks or product names of Siemens AG or supplier companies, the use of which by third parties for their own purposes may violate the rights of the owners.

### Industrial Security

Siemens provides automation and drive products with industrial-security functions that support the secure operation of plants or machines. They are an important component in a holistic industrial-security concept. With this in mind, our products undergo continuous development. We therefore recommend that you keep yourself informed with respect to our product updates and that you use only the latest versions. Please find further information on this subject at [automation.siemens.com/support](https://www.automation.siemens.com/support). You may also register for a product-specific newsletter at this address.

To ensure the secure operation of a plant or machine it is also necessary to take suitable preventive action (e.g., cell protection concept) and to integrate the automation and drive components into a state-of-the-art holistic industrial-security concept for the entire plant or machine. Any third-party products that may be in use must also be taken into account. Please find further information at [siemens.com/industrialsecurity](https://www.siemens.com/industrialsecurity).

Published by  
Siemens AG

Digital Industries  
Process Automation  
Östliche Rheinbrückenstr. 50  
76187 Karlsruhe, Germany

For the U.S. published by  
Siemens Industry Inc

100 Technology Drive  
Alpharetta, GA 30005  
United States

Article No.: DIPA-B10072-01-7600  
Dispo 10001  
WS 02201.5  
Printed in Germany  
© Siemens 2020

Follow us on:  
[twitter.com/siemensindustry](https://twitter.com/siemensindustry)  
[youtube.com/siemens](https://www.youtube.com/siemens)